



AM 3100 PIV System

Data Sheet v1.0



Table of Contents

- 1. Main Characteristic of the Pulse IV System..... 4
 - 1.1 General Specifications 4
 - 1.2 General Description..... 4
 - 1.3 Main features 6
 - 1.4 System configuration..... 6
- 2. Control Unit (AM3103) 7
 - 2.1 Connection and display 7
 - Front Panel 7
 - Rear Panel..... 7
 - 2.2 Cables and connectors 8
- 3. Gate Pulse SMU AM3111 (Embedded inside the AM3103 box) 9
 - 3.1 Main features 9
 - 3.2 Operating Area 10
 - 3.3 Electrical Specification..... 10
 - 3.4 Measurement..... 11
- 4. Drain Pulse SMU AM3121 12
 - 4.1 Description 12
 - 4.2 Voltage specification 12
 - 4.3 Operating area..... 12
 - 4.4 Pulse specification 13
 - 4.5 Measurement specification..... 13
 - 4.6 Current breaker specification..... 13
- 5. Drain Power Supply (Embedded inside AM3103 box) 15
 - 5.1 Main features 15
 - 5.2 Operating area..... 15
 - 5.3 Accuracy 15
 - 5.4 Dynamic performances 16
- 6. System Operation 17
 - 6.1 Start and stop process..... 17
 - 6.2 Pulse definition..... 17
 - 6.3 Measurement definition 18
 - General measurement performances 18
 - Automatic range..... 18
 - Measurement principle 19
- 7. Parts List 20
- 8. Mechanical Characteristics..... 21
- 9. Configuration of the AM3100 PIV System in IVCAD 22

9.1	AMCAD PIV Easy Configuration (IVCAD 3.8)	23
	I-V setup	23
	VNA based Load Pull setup.....	25
9.2	Manual configuration	26
	Input DC supplies (AM3111) configuration	27
	Output DC supplies (AM3121) configuration	30
	Pulsed IV Measurement units	31
9.3	Advanced options.....	35
	Contact Information	37

1. Main Characteristic of the Pulse IV System

1.1 General Specifications

	AM3111	AM3121
OPERATING RANGE		
Switched voltage level	2	1
Voltage	±25V	+120V
Pulsed current	±200mA	+30A
DC & RMS Current	100mA	5A
DC power	1W	220W
Pulsed power	3W	3000W
SOURCE PERFORMANCES		
Voltage setting resolution	16-bit 0.7mV	16-bit 2mV
Max Pulse length & Voltage drop		1ms & 1V@10A
Output impedances	50Ω	0.1Ω
Pulse Resolution	Resolution: 20ns ; Width: 1.1μs/10s ; Freq: 0.1Hz/200KHz	
Setting time to 95%	100ns	100ns
Programmable current breaker limits	Pulsed current and pulsed power	
Non-programmable safety stops	DC power ; Temperature	
MEASUREMENTS PERFORMANCES		
Sampling time delay resolution	20ns	
8 Measurement channels	2 user-defined sampling positions (M1,M2) * 2 parameters * 2 pulse SMU (Gate, Drain)	
Measurement range	Single range, according to operating range	
ADC resolution	16-bit	
Settling time	500ns	

1.2 General Description

The AM3100 is a standalone Pulsed IV system for Load Pull and general-purpose test applications. PIV systems are used to bias transistors or circuits in pulsed conditions to avoid self-heating and ensure quasi-isothermal conditions during the measurements.

Power amplifiers are often driven by pulsed RF signal combined with continuous or pulsed DC bias conditions. This brings some complexity to the bench configuration. Indeed, even when continuous DC voltages supplies are used, the pulsed RF signal magnitude will drive the transistor consumption in pulsed mode also, if the PA operates in saturated area. As the need is then to measure peak current to evaluate the peak efficiency, a need for synchronized DC multimeters operating in pulsed mode or an external oscilloscope is needed to run pulsed measurements, in addition with the DC supplies.

The AM3100 Pulsed IV system has been designed to replace DC supplies, multimeters and oscilloscope, and to provide the same measurement capabilities in a compact form factor and a cost-effective budget. The high-resolution SMUs capabilities associated with the advanced triggering functionalities make this system ideal for pulsed DUT characterization.

The storage capacitance on the channel 2 pulse head probe enables delivering high peak current (up to 30A) as close as possible of the DUT. Finally, this dual channel source can deliver pulsed voltage (from -25V to 25V) with a non-zero quiescent bias level on channel 1 and a synchronized pulsed high voltage (up to 120V) on channel 2 from 0V.

The PIV system consists of a Control Unit and a Pulse Head Probe (PHP).

The control unit (AM3103) drives an internal (Gate Pulse SMU) and external remote unit (AM3121) to supply and measure voltage and current at the input and output of a DUT. The main control unit includes:



Figure 1 AM3100 PIV System

- 250W AC/DC bloc which supplies all the internal parts and gate pulse modules (**inside AM3103**).
- 120V/5A 240 W power supply necessary to drive the AM3121 Remote unit.
- Commercial μ PC board with a USB hub
- Triggering interface.

AM3100 supports either LAN or USB connection to the PC and can be controlled using IVCAD or IQSTAR software's or through direct commands for user defined applications.

The remote unit is referred to as the drain pulse unit (AM3121) and combines the following hardware:

- Power switches
- Power drivers
- Overload protection devices
- Complete measurement and Analog to Digital conversion system
- Complete pulse and delay generation system

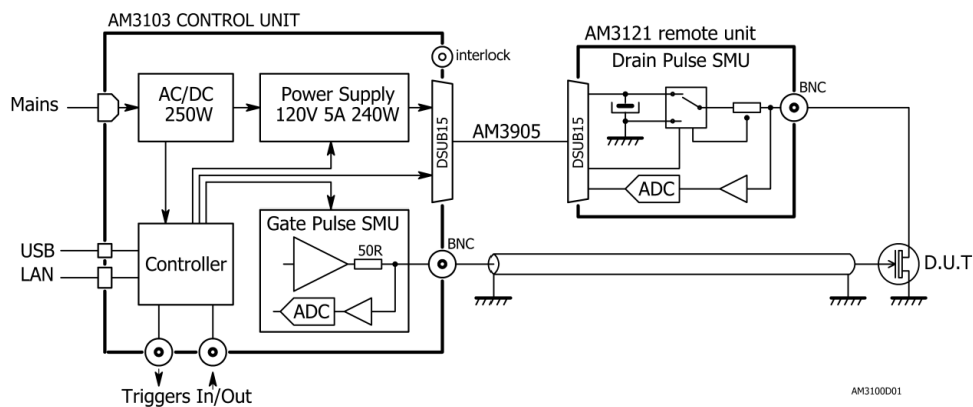

Figure 2 AM3100 system schematic

1.3 Main features

The system's main features are:

- Reliable pulse units with long lasting performances (thermal, SOA and DUT breakdown protections)
- Pulse or DC operation with pulse width down to 1us from the generator and for measurements.
- Internal and external synchronization
- Extended stop conditions and built-in protection
- Direct hardware programmability (SCPI commands)
- Embedded measurement units providing wide bandwidth and high accuracy for simultaneous current and voltage measurements
- Embedded fast short-circuit current breaker, performing the protection of the external pulse unit as well as external components such as Bias Tees.
- Remote control through LAN or USB.

1.4 System configuration

The configuration of the AM3100 consists of the main unit and one external pulse generator for the output of the device under test. The input is biased directly from the main unit using a BNC cable.



Figure 3 AM3100 system configuration

2. Control Unit (AM3103)

The control unit includes a gate pulse module and drives an external drain pulse unit. LAN and USB connections are supported for the remote control.

2.1 Connection and display

Front Panel

Pressing the ON/OFF button on the AM3100 will turn on the hardware. Blue LED blinks during the initialization (No communication is possible with the instrument while the operating system is starting). The system is ready when the LED light is steady.

The Front Panel is composed of:

- DSUB 15 connector for the Remote pulse unit and a powered LED
- BNC output 50Ohms for the input bias and a powered LED.
- SMA Interlock



Figure 4 AM3103 Control unit front panel

Rear Panel

The AM3103 rear panel is composed of:

- LAN/RJ45 connection with 3 digits displaying the IP address.
- USB2 type A connection used for firmware update
- USB2 type B connection can be used for the connection with a PC
- AC 100V/240V 50 H 60 Hz source connection
- 7 coaxial SMB connectors

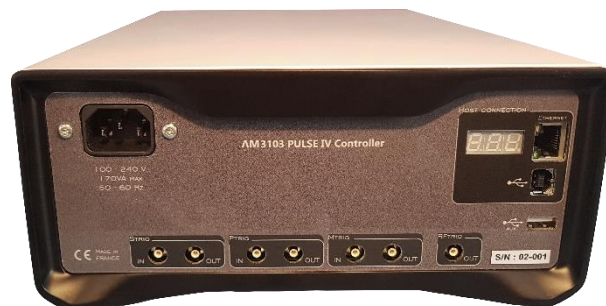

Figure 5 AM3103 Control unit rear panel

The Pulse IV system works with several programmable signals, which can give it the role of trigger box (like an Arbitrary Waveform Generator) in your setup.

The PIV system has 7 trigger connections (SMB connection) on the rear panel:

- **Pulse Trig in:** The input signal "**Ptrig-in**" is used to trigger the Pulse IV generator by an external device.
- **Pulse Trig out:** The output trigger signal "**Ptrig-out**" is generated by the Pulse IV with fixed duration (>2us), this one can be used to synchronize an external device such as an oscilloscope or a Digital Multi Meter.
- **Meas Trig in:** This signal is **not available** on the AM 3100 PIV system.
- **Meas Trig out:** The output signal "**Mtrig-out**" is an output periodic TTL signal that corresponds to the measurement window defined for the IV measurements.
- **Synchronization Trig in:** The input signal "**Strig-in**" (a periodic TTL signal) can be used to synchronize & protect two control unit (AM3103) in cascaded mode.
- **Synchronization Trig out:** The output signal "**Strig-out**" is an output periodic TTL signal can be used to synchronize & protect two control unit (AM3103) in cascaded mode.
- **RF trig out:** The output signal "**RFtrig-out**" can be used to drive an external RF modulator that will require an output periodic TTL signal drive (application can be pulsed IV and pulsed Load Pull measurement for example)

2.2 Cables and connectors

One cable **AM3905** is provided with the system to connect the control unit to the AM3121 drain probe. See wiring configuration below:

- Three fast differential signals: USB, STRIG, PTRIG
- Two simple logic signals: MTRIG, ALARM



Figure 6 AM3905 Connection cable

3. Gate Pulse SMU AM3111 (Embedded inside the AM3103 box)

3.1 Main features

- 4-quadrant DC or Pulse voltage source.
- Down to 1 μ s pulse width, 20ns time resolution.
- Simultaneous voltage and current sampling.
- Pulse and Quiescent level sampling time points can be chosen automatically by the source or manually by the user.

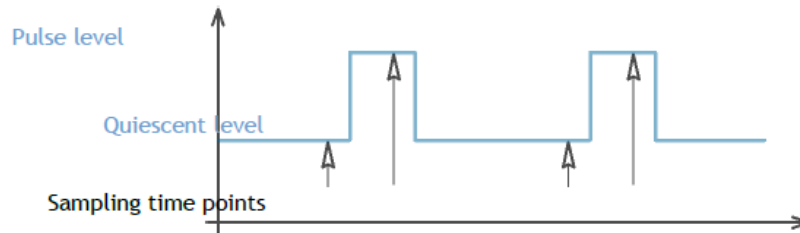

Figure 7 Gate waveform Sampling

- 1 voltage range: $\pm 25V$
- 2 current ranges: $\pm 5mA$ and $\pm 200mA$
- No transient when powering on/off or switching on/off
- Output on isolated BNC connector
- Operating range:
 - o DC: Gray area, Pulse: Gray + Lilas areas

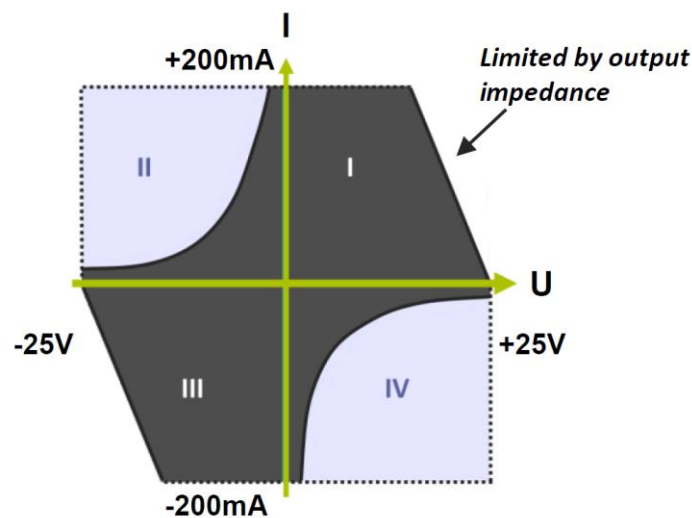

Figure 8 AM3111 Operating area

3.2 Operating Area

Parameters	Conditions/Comments	Min	Max
Voltage programming range		-25V	25V
Pulse amplitude	Maximum difference between pulse and quiescent levels	-30V	30V
Output current	Guaranteed: source stops if +/-260mA is exceeded	-200mA	200mA
Output power	Source, DC		3W
	Sink, DC		0.5W
Pulse	Width	1.1 μ s	10s
	Frequency	0.1Hz	200kHz
	Duty cycle	0%	100%
Temperature	Ambient temperature in front of the chassis rear openings	10°C	30°C

3.3 Electrical Specification

Parameters	Conditions/Comments	Value
Voltage programming resolution	16-bit	1mV
Voltage programming accuracy	2-year accuracy, no load	50mV+0.2%
Voltage noise	0.1Hz-10kHz, peak to peak noise, no load	1mV
	0.1Hz-5MHz, peak to peak noise, no load	3mV
Voltage cross-talk Vq/Vp setting	Vq voltage drop for any Vp setting modification	0.5mV/V
Voltage settling time	Pulse, 0% to 95%, no load	100ns
	DC, 0 to 95%	100ms
Time resolution	Pulse and measurement time resolution	20ns
Overload response time	Source stops if +/-260mA is exceeded	60ns
Output impedance	Source ON	50 Ω +/-1%
	Source OFF, between both outputs; max. allowed current: 1A	50m Ω
Output capacitance	Internal output capacitance	20pF
Earth isolation	Isolation voltage	+/-50V max.
	Isolation resistance	~50k Ω
	Capacitance between any output terminal and the earth	100nF

3.4 Measurement

Parameters	Conditions/Comments	25V range	200mA range	5mA range
ADC resolution	16-bit	0.9mV	7 μ A	170nA
Noise		+/-2mV	+/-30 μ A	+/-5 μ A
Settling time	To 95% To ADC resolution	0.5 μ s 2 μ s	0.5 μ s 2 μ s	1 μ s 4 μ s
Absolute accuracy	Offset + % of reading, 2-year	7.5mV + 0.1%	100 μ A + 0.2%	10 μ A + 0.2%

4. Drain Pulse SMU AM3121

4.1 Description

The AM3121 Pulse SMU is a power probe dedicated to bias the transistor drain (Positive voltages). Optimized for high power pulsed measurements applications (120V, 30A), this probe head can be used either for Load Pull applications or general-purpose pulsed SMU.

The output connector is a BNC. The AM3121 does not have sense connection.

The DSUB 15 connector is for power and control.



Figure 9 AM3121 Drain Pulse unit

4.2 Voltage specification

Parameters	Conditions	Max
Maximum input voltage		120V
Storage capacitor		6.8mF
Overall ESR from capacitor to output contacts		50mΩ
Voltage drop during pulse, related to internal ESR	30A	1.5V
Voltage drop rate during pulse, related to internal capacitor	30A	4V/ms

4.3 Operating area

Parameters	Conditions	Value
Pulsed current		30A
Average current		5A
RMS current		10A
Pulsed current		3000W
DC power		220W
Earth isolation	Between power gnd. and earth	220kΩ 120V

4.4 Pulse specification

Parameters	Conditions/Comments	Min	Max
Duty cycle	Any level, according	0%	100%
Frequency		0.1Hz	100kHz
Pulse width	$I_{max} = 30A$	1.1 μ s	10s
Timing resolution		20ns	
Pulse settling time	0% to 95%, no load		50ns

4.5 Measurement specification

Parameters	Conditions/Comments	Voltage	Current
Measurement range		125V	33A
ADC resolution	16 bits	2.1mV	550 μ A
Settling time	To 95% To ADC resolution	0.5 μ s 2 μ s	0.5 μ s 2 μ s
Noise		+/-15mV	+/-2mA
Absolute accuracy	Offset + gain	20mV + 0.1%	20mA + 0.3%

4.6 Current breaker specification

Parameters	Conditions	Value
Threshold setting range		1A / 33A
Threshold setting resolution		12 bit, 10mA
Threshold setting accuracy	Offset + % of current	200mA + 0.5%
Response time	Current step / threshold + 20 %	100ns

The **Strig** signal performs overall synchronization of start, stop, and emergency stop.

Using either constant level or pulsed mode, the P signal performs overall synchronization of the power pulse, the measurement sampling time and the transient mask.

The transient mask allows the user to define a larger current breaker level at the time the voltage and/or the current is switched on. Then, the current breaker level after complete settling can be set closer to the expected level.

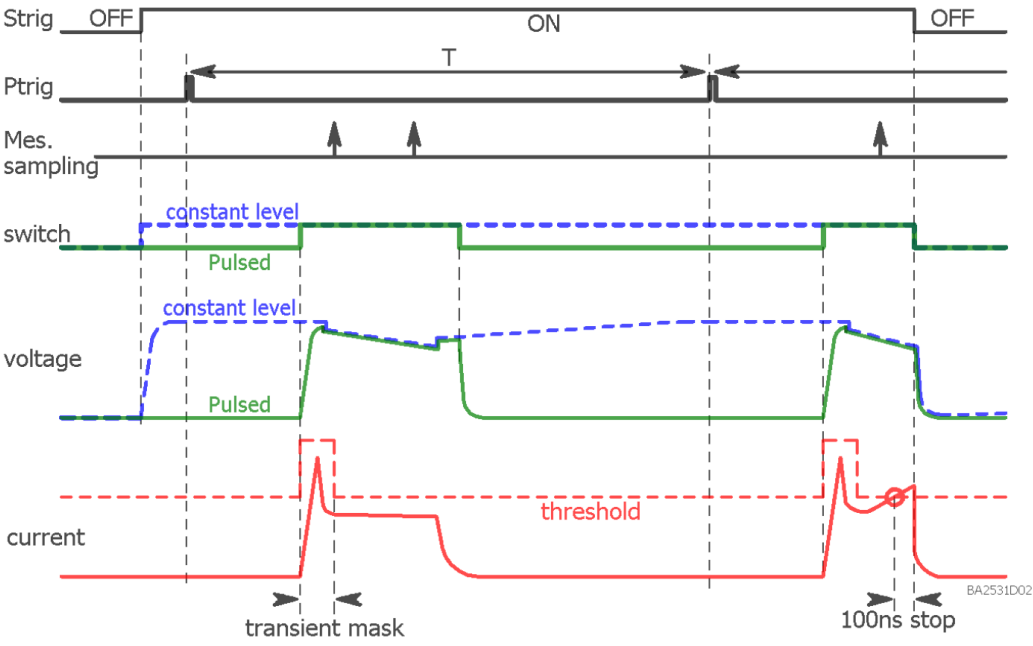

Figure 10 Transient mask principle

5. Drain Power Supply (Embedded inside AM3103 box)

5.1 Main features

- isolated DC voltage source
- Fast toggling current and power limitation
- 2-quadrant, source & sink operating area:
- 18-bit voltage programming, no missing code
- Safe charging and discharging of any load capacitor
- Programmable voltage slope
- No transient when powering on/off

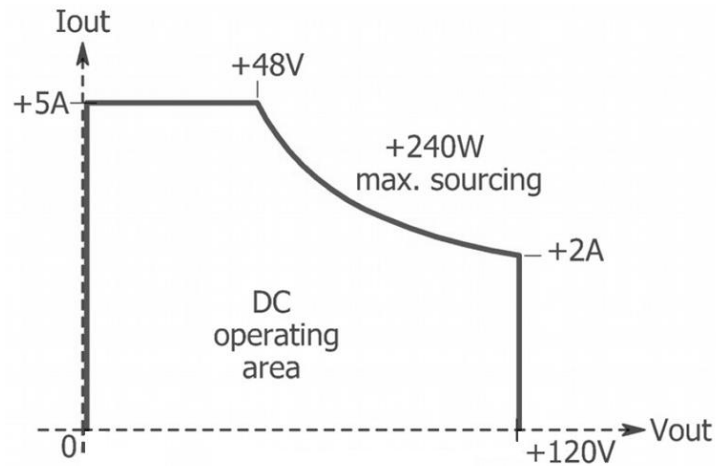

Figure 11 Drain power supply Operating area

5.2 Operating area

Parameters	Conditions/Comments	Min.	Typ.	Max.
Voltage programming range		0		+120V
Current compliance range	Programmable maximum sourcing current limit	+250mA		5A
Source output power	DC or transient operation, fast toggling limitation		240W	
Sink output power	DC or transient operation, fast toggling limitation		24W	
Operating temperature	Ambient temperature, 80% RH non-condensing	+15°C		+30°C
Earth isolation	Between power gnd and earth	220kΩ & 300nF		

5.3 Accuracy

Parameters	Voltage programming
Range	0V / +120V

Resolution	18bit / 0.5mV
2-year accuracy	+/- 40mV +/- 0.1%

Accuracy specified on an +18°C/ +28°C ambient temperature range, after a 1-hour warm-up.

5.4 Dynamic performances

Parameters	Conditions/Comments	Min.	Typ.	Max.
User external output capacitor	Safe and stable whatever the capacitor	0	10mF	100mF
Internal output capacitor	Equivalent total value of the output filter		100μF	
Current step response time	Switching load, 0A to 5A or 0W to 240W		50μs	
Small voltage step settling time	1V step, no load, step mode, to 95%		12ms	
Full range rise time & fall time	0 to 120V, no load, step mode, current limit = 5.1A		30ms	
Large capacitor charging time	0 to 120V, 10mF load, step mode, current limit = 5.1A		400ms	
Large capacitor discharging time	120V to 0, 10mF load, step mode		2.7s	
Voltage slope programming	voltage slope generated by 1ms sampling rate	1mV/ms		120V/ms

6. System Operation

6.1 Start and stop process

START process:

1. Switching on the power supply, waiting for the requested levels.
2. When the rising edge of “Strig” is detected, the output gate pulse unit is set to its associated quiescent level.
3. After a $1\mu\text{s}$ fixed delay, the output drain pulse unit is set to the 0V quiescent level.
4. When the second valid “Ptrig” after the rising edge of “Strig” is detected, the pulse levels are reached for the gate, drain and “Rftrig” with a phase compliant to the requested chronograms.

STOP process:

1. When the first falling edge of “Strig” is detected, the output drain pulse unit (0V) & “Rftrig” (Low level) are disabled asynchronously with Ptrig.
2. After a $1\mu\text{s}$ fixed delay, the gate is set to 0V asynchronously with Ptrig.
3. Switching off the power supply

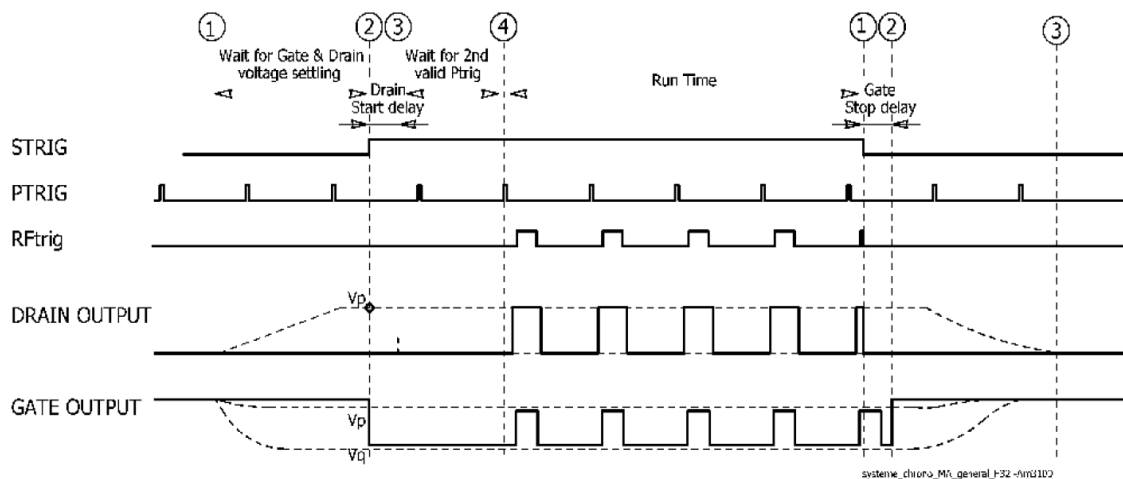

Figure 12 Start and Stop process chronogram

Note: the $1\mu\text{s}$ fixed delay is meant to cover the maximum rise/fall time of the pulse units.

6.2 Pulse definition

The pulse timing is computed inside each pulse unit, using a 50MHz clock which is synchronized by the “Ptrig” pulse. The internal time reference of each pulse unit exhibits a calibrated minimum delay of 200ns and a maximum time jitter of $\pm 2.5\text{ns}$.

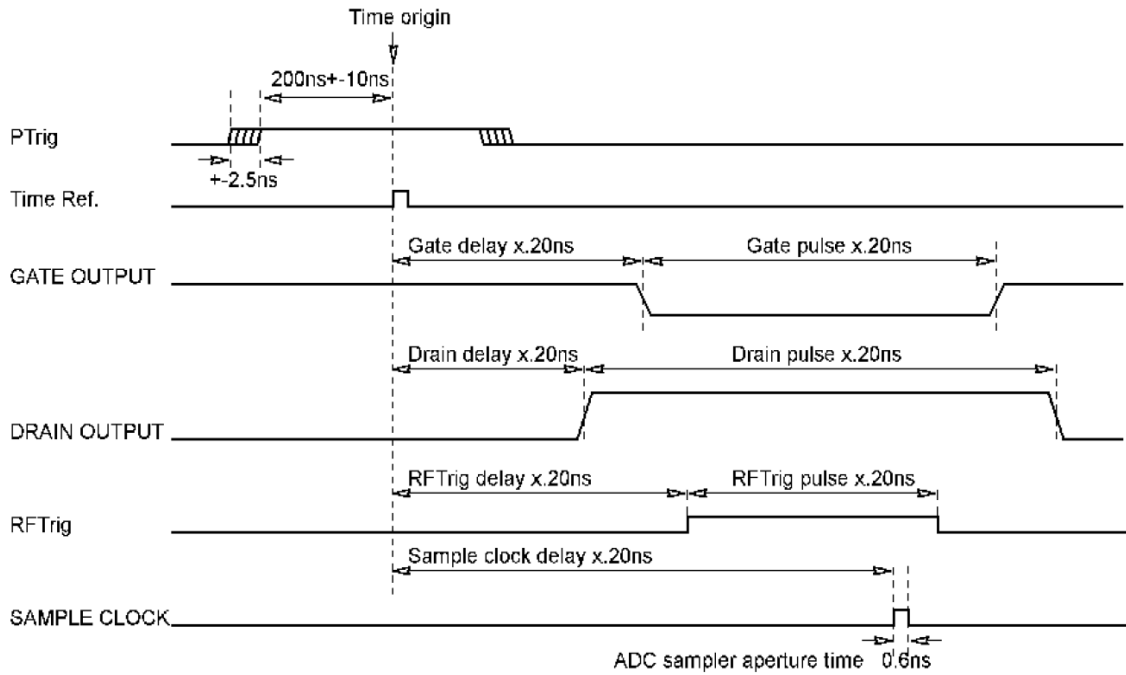

Figure 13 AM3100 pulse timing definition

Parameters	Conditions/Comments	Spec.	Min.	Max.
Time jitter	Ptrig to any output			$\pm 2.5\text{ns}$
Minimum time delay from PTrig	Fixed delay from Ptrig to any output	200ns	190ns	210ns
Time delay calibration error	Parameter inside each pulse	$\pm 10\text{ns}$		
Time resolution	Delay and duration counting	20ns		
Internal PTrig range	Period (timer resolution $1\mu\text{s}$) Frequency		$5\mu\text{s}$ 200kHz	10s 0.1Hz

6.3 Measurement definition

General measurement performances

Parameters	Spec.
ADC sampler aperture time	0.6ns
Programmable measurement delay resolution	20ns
Measurement settling time	500ns
ADC resolution	16 bits
Update rate between two measurements	$\gg 15\text{ms}$
Jitter between 2 measurements	50ms

Automatic range

The automatic range allows to switch automatically to the appropriated range during the measurement, in order to keep the maximum measurement accuracy.

Measurement principle

- The software offers the user Only 2 measurement times (M1 & M2). These two measurement instants have a free position before, during or after the Ptrig pulse.
- The conditions on M1 and M2 locations are:
 - o $M2 > M1$,
 - o $M2 - M1 > 2\mu\text{s}$
 - o $M2 \leq \text{Period} - 2\mu\text{s}$
- The measurement system does not have a buffer.

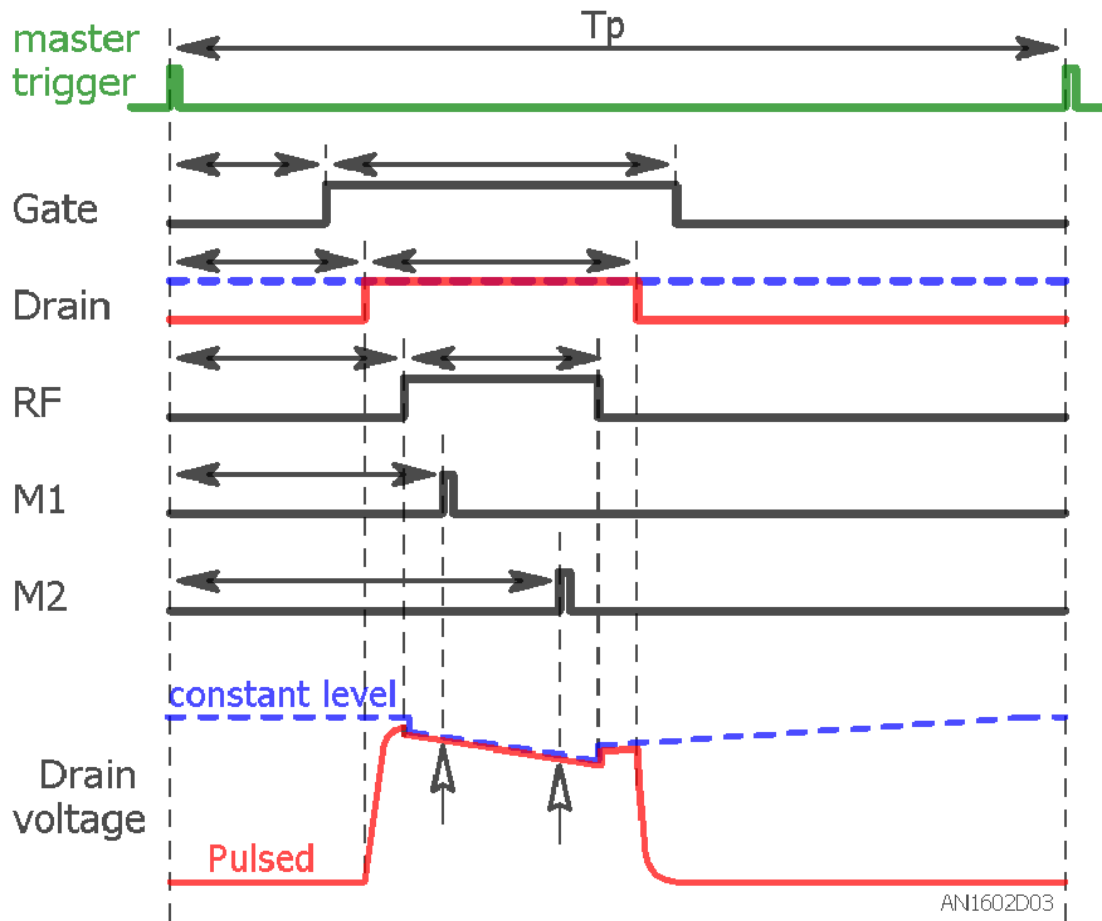

Figure 14 Measurement principle

7. Parts List

Basic setup	
AM3103	Control box including Drain power supply and Gate pulse SMU
AM3121	Remote Drain pulse SMU +120V 30A
Cable set supplied with the basic system	
AM3103 set	1 DSUB15 cable AM3905, for remote Drain SMU
	1 USB cable
	1 RJ45 cable
	1 European IEC C13 mains cable
	1 US IEC C13 mains cable

8. Mechanical Characteristics

AM3103 (Control box) + AM3111(Embedded inside the Control box)

- Weight: 4.58kg (10.097 lb)
- Length:355.6 mm (14")
- Width:220.98mm (8.7")
- Height: 85.09mm (3.35")

AM3111 (Drain Probe)

- Weight: 1.58kg (3.483 lb)
- Length:190.5mm (7.5")
- Width:139.7mm (5.5")
- Height: 76.2mm (3") without legs

9. Configuration of the AM3100 PIV System in IVCAD

Before starting IVCAD, the AM3100 needs to be added in the VISA layer. As shown below in the example, "Keysight Connection Expert" or "National Instruments NI Max" free software add the AM3100 as a LAN device.

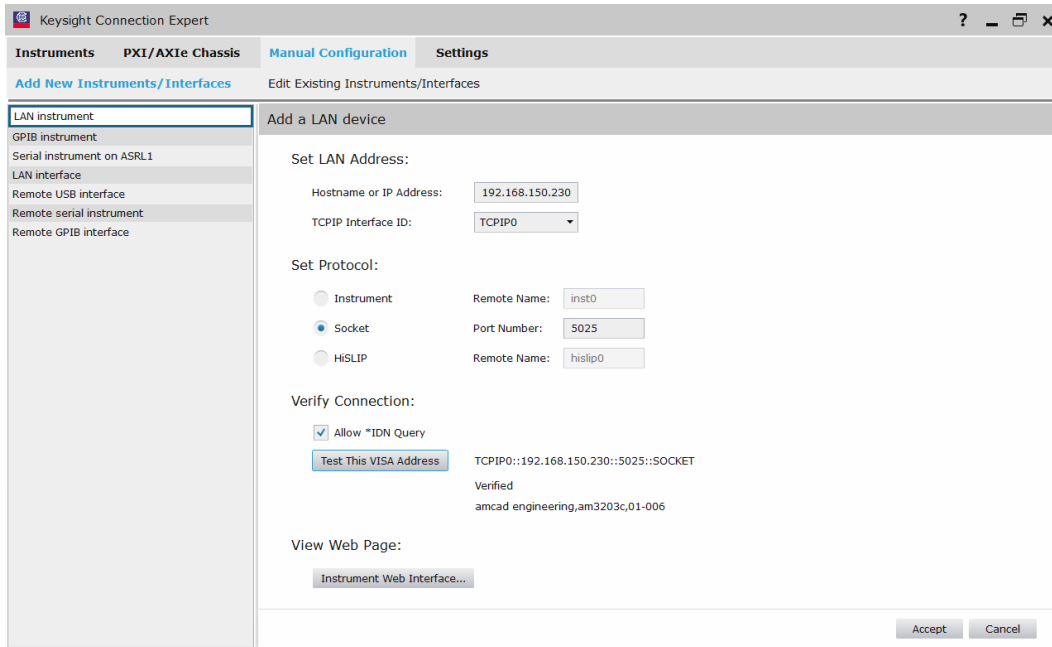

Figure 15 AM3100 added as instrument using Keysight Connection Expert software

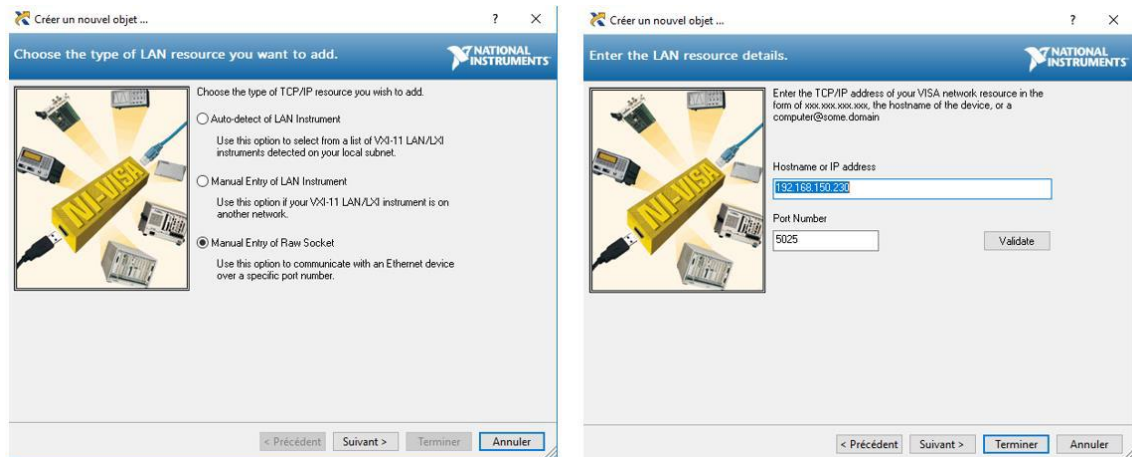

Figure 16 AM3100 added as instrument using NI Max software

After launching IVCAD, the first step is to choose the measurement setup by clicking on "New" in "Measurement system-> Measurement->Setup & Measurement". Then, three measurement setups are proposed as depicted below:

- IV measurement
- Load Pull measurement
- Traditional Load Pull measurement

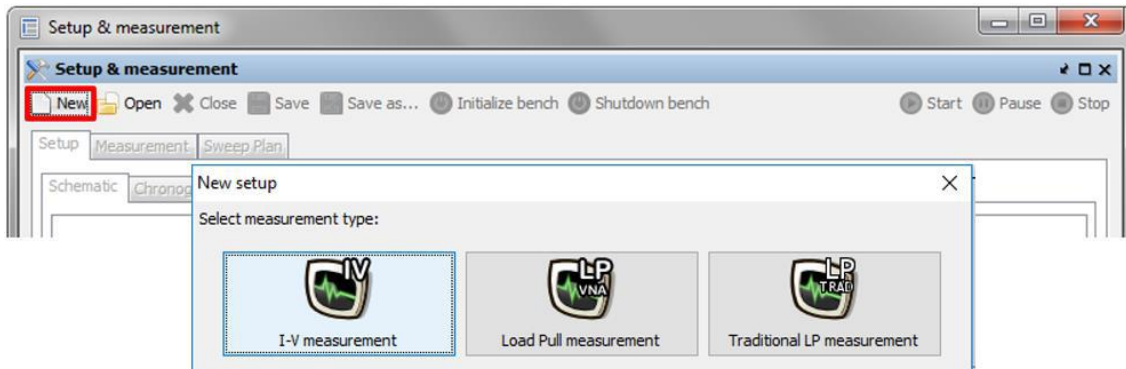

Figure 17 New setup in IVCAD

In this section, two configuration methods are presented to drive the PIV 3100 using IVCAD software.

9.1 AMCAD PIV Easy Configuration (IVCAD 3.8)

In order to help users set the AMCAD PIV system (AM200 series & AM3000 series), IVCAD embeds an easy configurator (since IVCAD 3.7). This feature allows to easily configure your IVCAD I-V and VNA based Load-Pull setups.

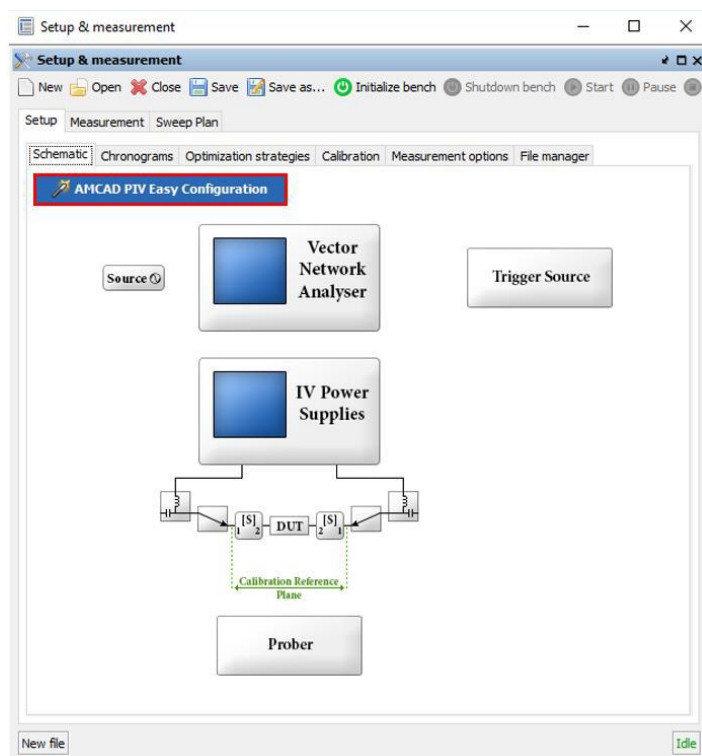

Figure 18 AMCAD PIV Easy configuration access

I-V setup

This part proposes to set an I-V measurement setup using “AMCAD PIV Easy Configuration”.

Figure 19 Example of AMCAD PIV easy configuration for an IV setup

The configuration begins by selecting some general parameters:

- Activate or not the RF measurement (S-parameters...)
- Choose the "Mode": DC or Pulsed.

Then, the PIV system (power supply) must be set:

- Choose the system "AMCAD PIV 3000 series".
- Enter the VISA address, clicking on the magnifying glass and choosing the PIV system.
- If the PIV system is in Pulsed mode, the "Period" and the "Duty Cycle" must be set.
- The bias can be applied firstly on the "Input" or the "Output" thanks to the "Priority" field. If the user selects "None" both biases ("Input" and "output") are applied at the same time.

Then the last part is dedicated to the VNA configuration. If the "RF needs to be measured" box is selected.

- Choose your VNA in the "System" list.
- Enter the VISA address, clicking on the magnifying glass.
- Select the Input and the output ports.
- Select the IF bandwidth and the Filter mode.

Then clicking on OK, IVCAD will fill automatically all the parameters needed to "Initialize" the bench directly.

The AM 3100 PIV System measures **ONLY 2** points in the pulse (see section 6.3):

- The first measurement instant is M1. It corresponds to the quiescent level measured at the beginning of the I-V trace window. **This window must start at 1µs or greater.**

- The second measurement instant is M2. It corresponds to the left cursor of the measurement window.

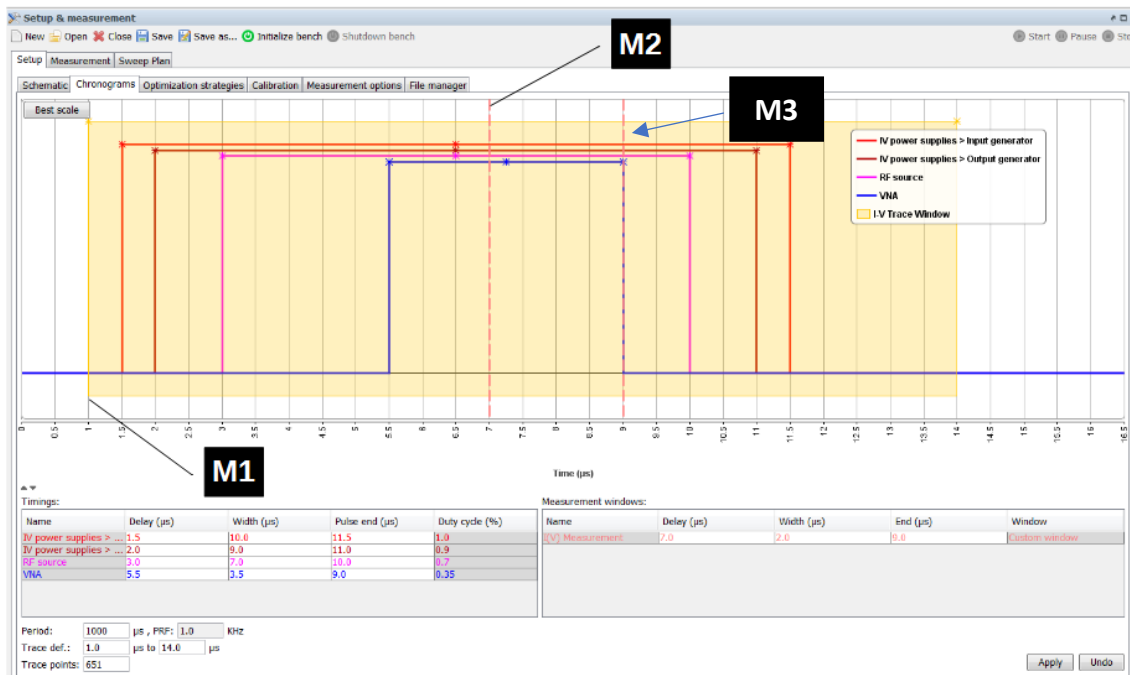

Figure 20 Example of Chronogram defined with the AMCAD PIV easy configurator

The right cursor (M3) will be used by other equipment (Multimeter, SMU). In this case, the measurements will be done in the window [M2-M3] and the software will define the number of points needed. The length of the measurement window and the number of points in the pulse are defined by IVCAD to ensure a good trade-off between speed and accuracy. The proposed pulse timing can be modified directly in the Chronogram tab (refer to 'IVCAD MT930JK OM PIV' documentation).

NOTE: as M3 will always be visible in the Chronogram, it will be simply ignored when using AM3100.

VNA based Load Pull setup

This part proposes to set a Load Pull measurement setup using "AMCAD PIV Easy Configuration". For the VNA based Load-Pull, the AMCAD PIV Easy Configuration window is similar to the "AMCAD PIV Easy Configuration" of the IV setup, adding the power meter setting. Clicking on OK, all the parameters and chronogram are automatically set, only the source and load tuning station remains unset. When your source and load tuning setting has been manually configured, the calibration can be directly performed.

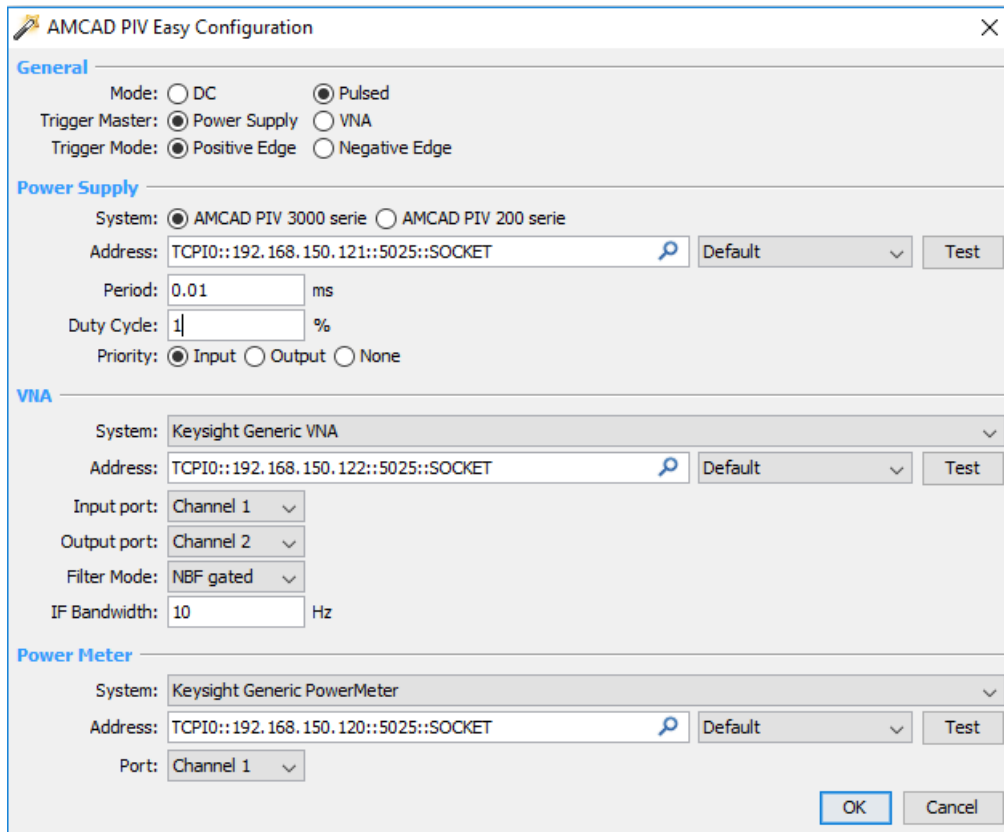

Figure 21 Example of AMCAD PIV Easy configuration for an LP setup

9.2 Manual configuration

The AM3100 system has to be set and defined in the 'DC Power supplies' block of the IVCAD schematic.



Figure 22 IVCAD IV Power Supplies block

The 'DC or Power Supplies' setup window is common with the 'I-V Measurement units. It is divided into four configuration settings:

- Power supply** used to define the power supplies
- Resistive network** used to define the resistive networks
- Voltage measurement** used to define the instruments for the voltage measurement
- Current measurement** used to define the instruments for the current measurement

When clicking on 'DC or Pulse Power Supplies', the following window appears:

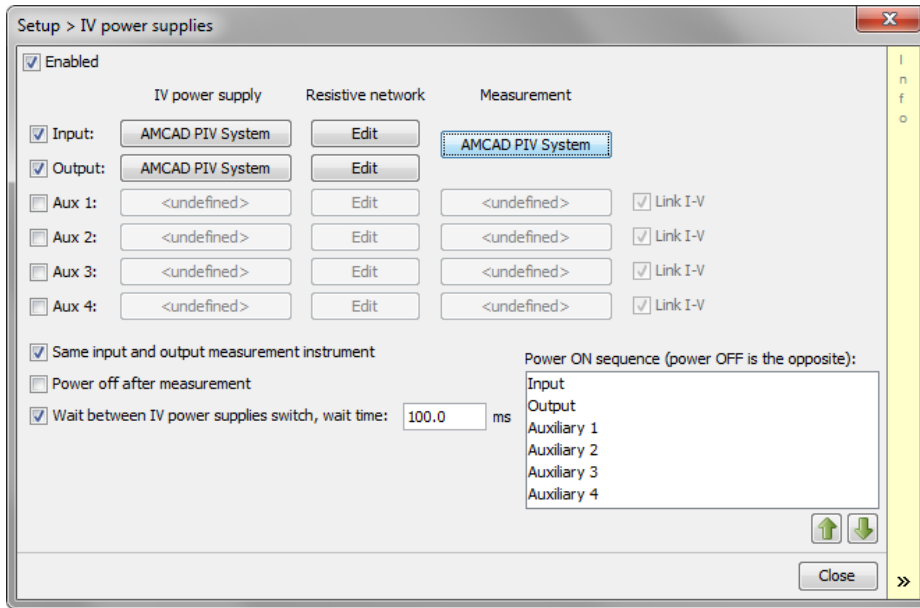

Figure 23 IVCAD IV power supplies & IV measurement window

Input DC supplies (AM3111) configuration

The input power supply is generally used to bias the gate access of a transistor. For AM3100 systems, the input DC supply corresponds to the AM3111 gate probe head.

By clicking on an 'Input Power supply', the following window is displayed:

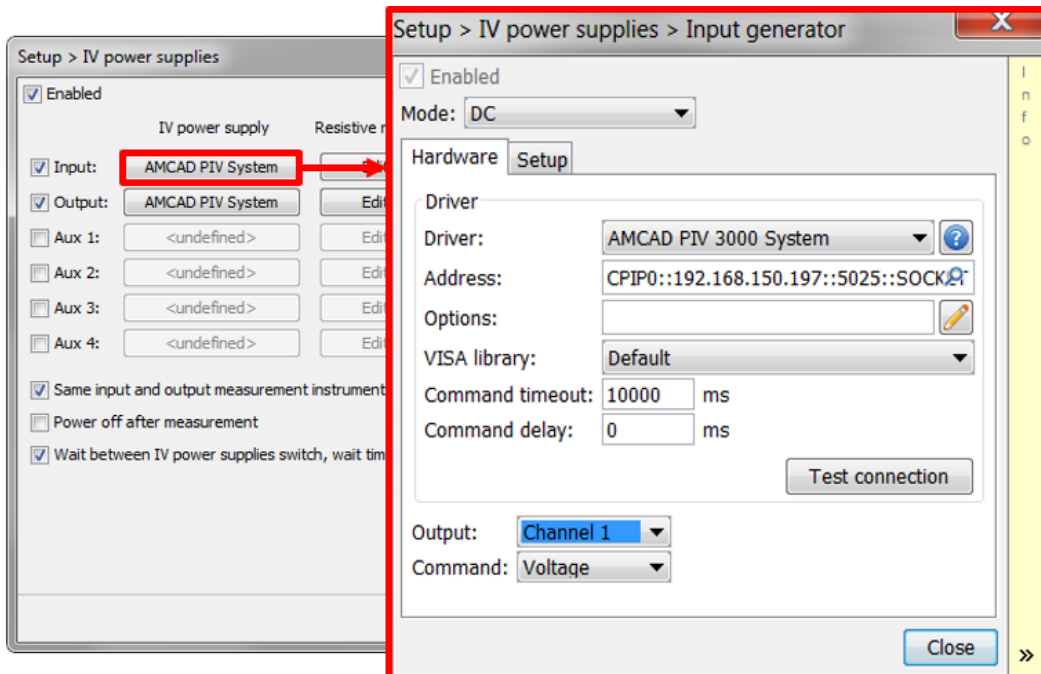

Figure 24 Input IV Power Supplies configuration

Mode	choose the measurement mode (CW or Pulsed)
Driver	select AMCAD PIV 3000 System
URL	set the TCP/IP Address
Options	additional driver options (depends of selected driver)
VISA implementation	set the VISA DLL which will be used to communicate with this instrument
Command timeout	elapsed time before returning an error message if no response
Command delay	delay before sending a command
Test connection	send a command to the GPIB bus to test the instrument connection
Output	select the Channel 1
Command	select Voltage or Current

The fields to fill in the 'Setup' tab depend on the selected mode:

- DC mode

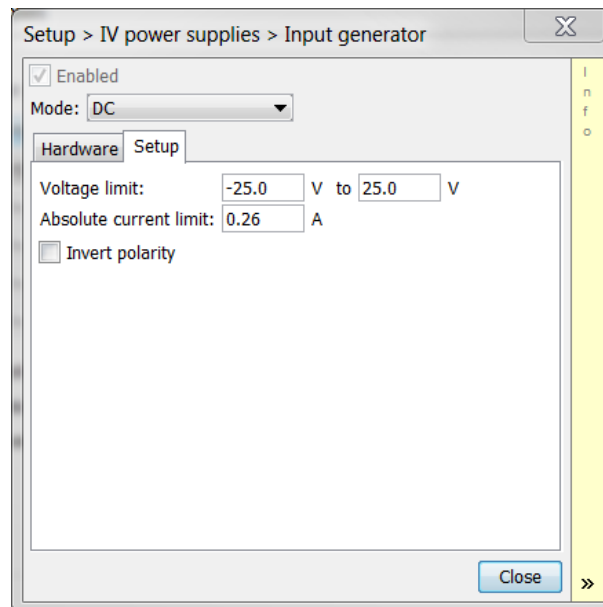

Figure 25 Input IV Power Supplies in DC mode configuration

Bias Voltage limit	set the minimum and the maximum voltage limits of the probe (-25V to +25V for the AM3111)
Bias Absolute current	set the maximum transient current limit achievable by the AM3111 (0.26A).

- Pulsed mode

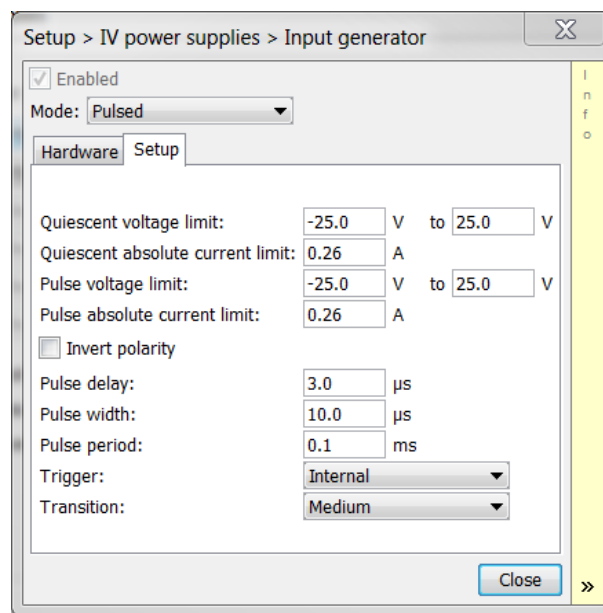

Figure 26 Input IV Power Supplies in Pulsed mode configuration

Bias Voltage limit	set the minimum and the maximum voltage limits of the probe (-25V to +25V for the AM3111)
Bias Absolute current	set the maximum transient current limit achievable by the AM3211 (0.26A)
Pulse Voltage limit	set the minimum and maximum voltage limits of the probe (-25V to +25V for the AM3211)
Pulse absolute current limit	set the maximum transient current limit achievable by the AM3111 (0.26A)
Pulse delay	set the pulse delay ¹
Pulse width	set the pulse width
Pulse period	set the pulse period
Trigger	select internal or external trigger. The internal trigger signal comes from the PIV system, whereas an external trigger signal comes from another instrument.
Transition	select the transition mode. The transition mode will modify the rise time of the pulsed signal, which depends on the characteristics of the PIV system as well as the operating conditions (DUT characteristics, bias tees...). For the AM3111 gate probe the transition: 'Smooth', 'Medium' and 'Hard' are available.

¹ These timings can be re-adjusted in the « Chronograms » tab

Output DC supplies (AM3121) configuration

The output power supply is generally used to bias the drain access of a transistor. Select **Channel 2** as Output, as illustrated below:

The fields to fill in the 'Setup' tab depend on the selected mode:

- DC mode

Bias Voltage limit set the minimum and the maximum voltage limits of the probe (0 to +120V for the AM3121)

Bias Absolute current set the maximum transient current limit achievable by the AM3121 (30A)

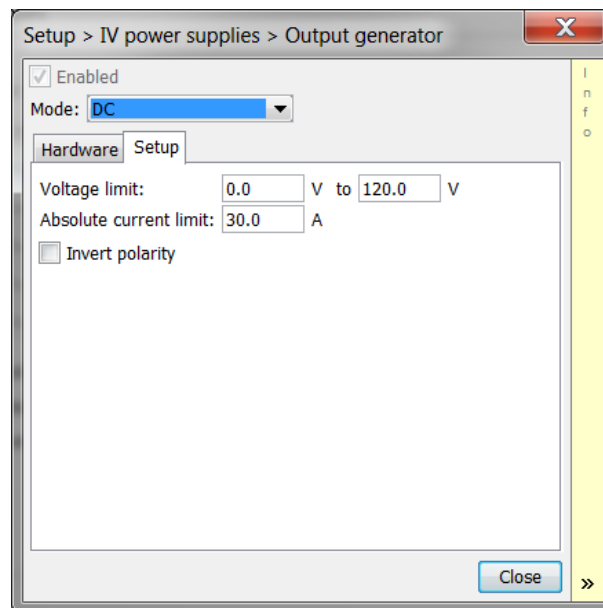

Figure 27 Output IV Power Supplies in DC mode configuration (AM3121)

- Pulsed mode

Bias Voltage limit set the minimum and the maximum voltage limits of the probe (0V for the AM3121)

Bias Absolute current set the maximum transient current limit achievable by the AM3121 (30A)

Pulse Voltage limit set the minimum and maximum voltage limits of the probe (0V to +120V for the AM3121)

Pulse absolute current limit set the maximum transient current limit achievable by the AM3211 (30A)

Pulse delay set the pulse delay²

Pulse width set the pulse width

Pulse period set the pulse period

² These timings can be re-adjusted in the « Chronograms » tab

Trigger

select internal or external trigger. The internal trigger signal comes from the PIV system, whereas an external trigger signal comes from another instrument.

Transition

select the transition mode. The transition mode will modify the rise time of the pulsed signal, which depends on the characteristics of the PIV system as well as the operating conditions (DUT characteristics, bias tees...). For the AM3121 drain probe only the “Medium” transition is available.

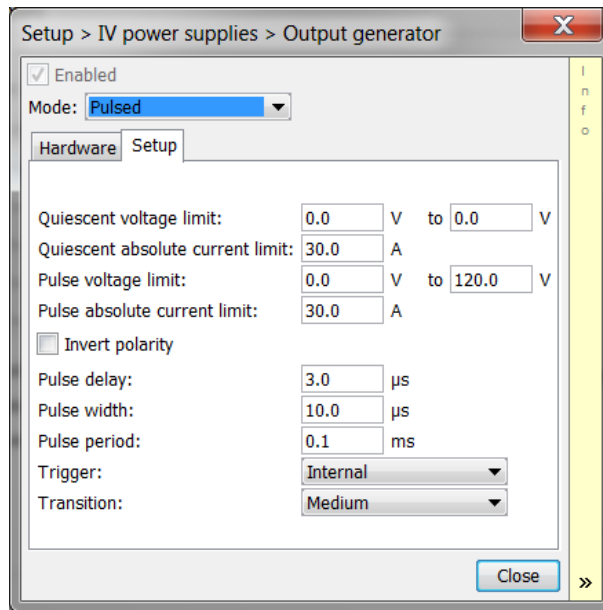

Figure 28 Output IV Power Supplies in Pulsed mode configuration (AM3121)

Pulsed IV Measurement units

AM3100 system uses a single instrument to measure both input and output (gate and drain) voltages and currents. Therefore the ‘Same input and output measurement units’ check box must be activated.

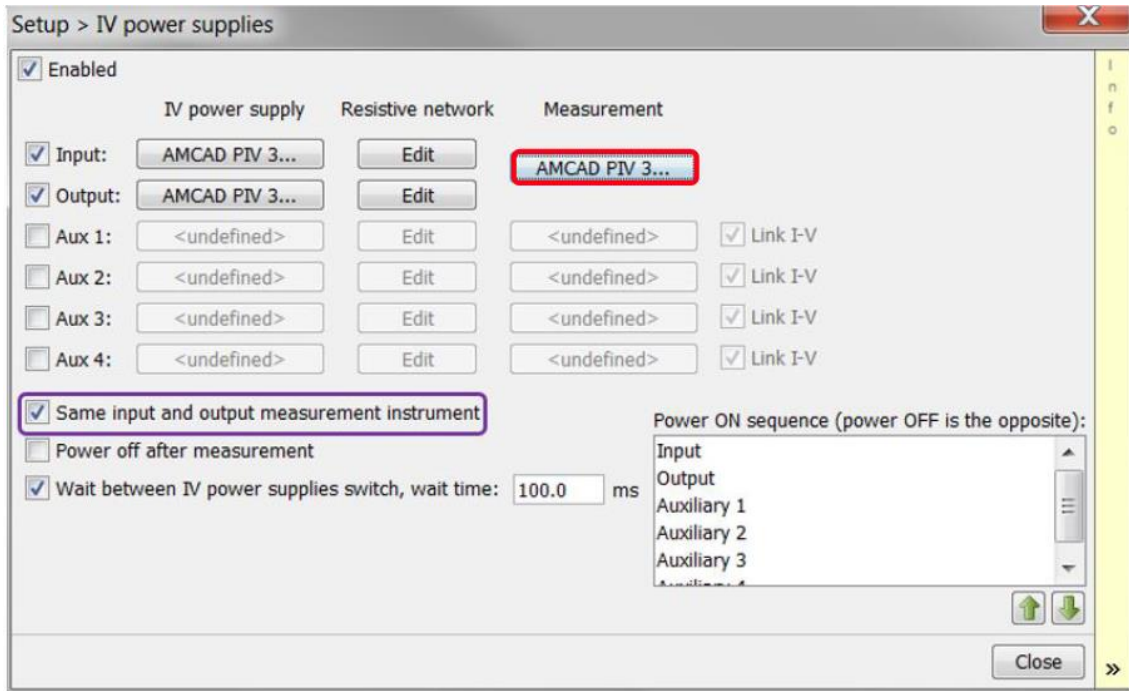

Figure 29 IV Measurement configuration for AM3100 system

Clicking on 'Input/Output Measurement', the following window is displayed:

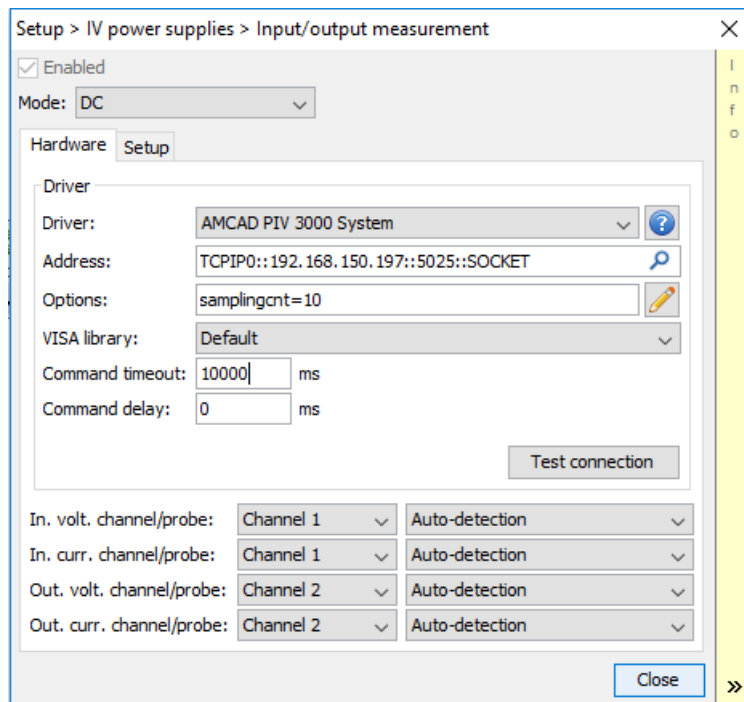

Figure 30 Input/Output Measurement configuration

Mode	chose the measurement mode (CW or Pulsed)
Driver	select AMCAD PIV 3000 System
URL	set the TCP/IP Address
Options	additional driver options (depends of selected driver)
VISA implementation	set the VISA DLL what will be used to communicate with this instrument
Command timeout	elapsed time before returning an error message if no response
Command delay	delay before sending a command
Test connection	send a command to the GPIB bus to test the instrument connection
In. volt. Channel/probe	select the Channel 1 => Autodetection
In. curr. Channel/probe	select the Channel 1 => Autodetection
Out. volt. Channel/probe	select the Channel 2 => Autodetection
Out. curr. Channel/probe	select the Channel 2 => Autodetection

The fields to fill in the 'Setup' tab depend on the selected mode:

- DC mode

Averaging	for the AM3100 system averaging needs to be set at 1 . The averaging is not possible on this instrument.
Correction factor	set correction factor, which multiplies the value of the measurement
Correction offset	set correction offset, which adds (or subtracts) a constant value

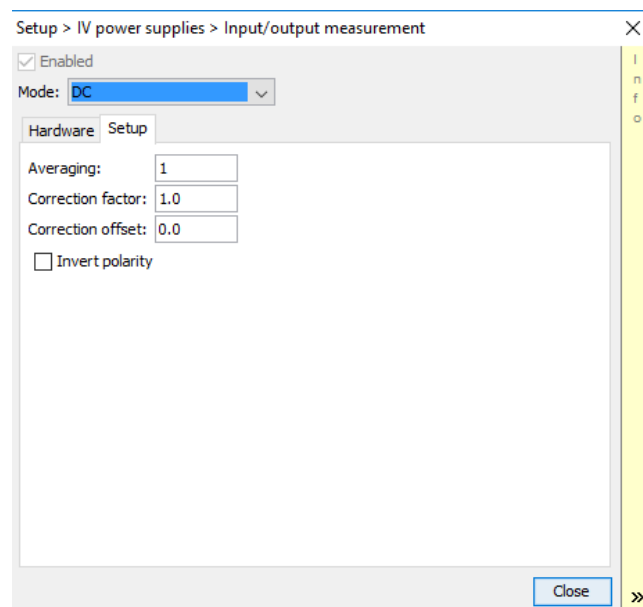

Figure 31 Input/Output measurement in DC mode configuration

- Pulsed mode

Averaging	for the AM3100 system averaging needs to be set at 1 . The averaging is not possible on this instrument.
Correction factor	set correction factor, which multiplies the value of the measurement
Correction offset	set correction offset, which adds (or subtracts) a constant value
Trigger	select internal or external trigger. For the AM3100 <u>measurement units</u> , it is recommended to always set the trigger as an internal trigger even if the AM3100 <u>generator</u> is defined with an external trigger.
Trace def	Defines the window which contains the full pulse shape. When using the AM3100 system, the Trace def must start at 1 μ s or greater. The beginning of the Trace def also defines the moment of the quiescent level's measurement.
Trace point.	Defines the number of points which contains the full pulse shape. When using the AM3100 system, this parameter has no influence if Tracedef > 2 because 2 points are acquired by the PIV measurement.
Meas. window	Defines the window where the measurements are performed to plot the IV network. The end of the measurement window defines the moment of the pulsed level's measurement. "Measurement window" lets to synchronize with the RF signal, with VNA measurement, or use a customized window.

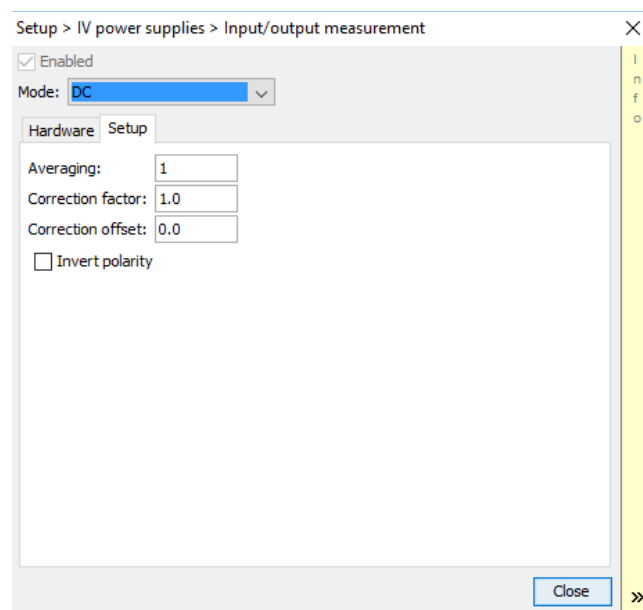

Figure 32 Input/Output measurement in Pulsed mode configuration

9.3 Advanced options

The “Measurement range” option allows the user to define different measurement range modes.

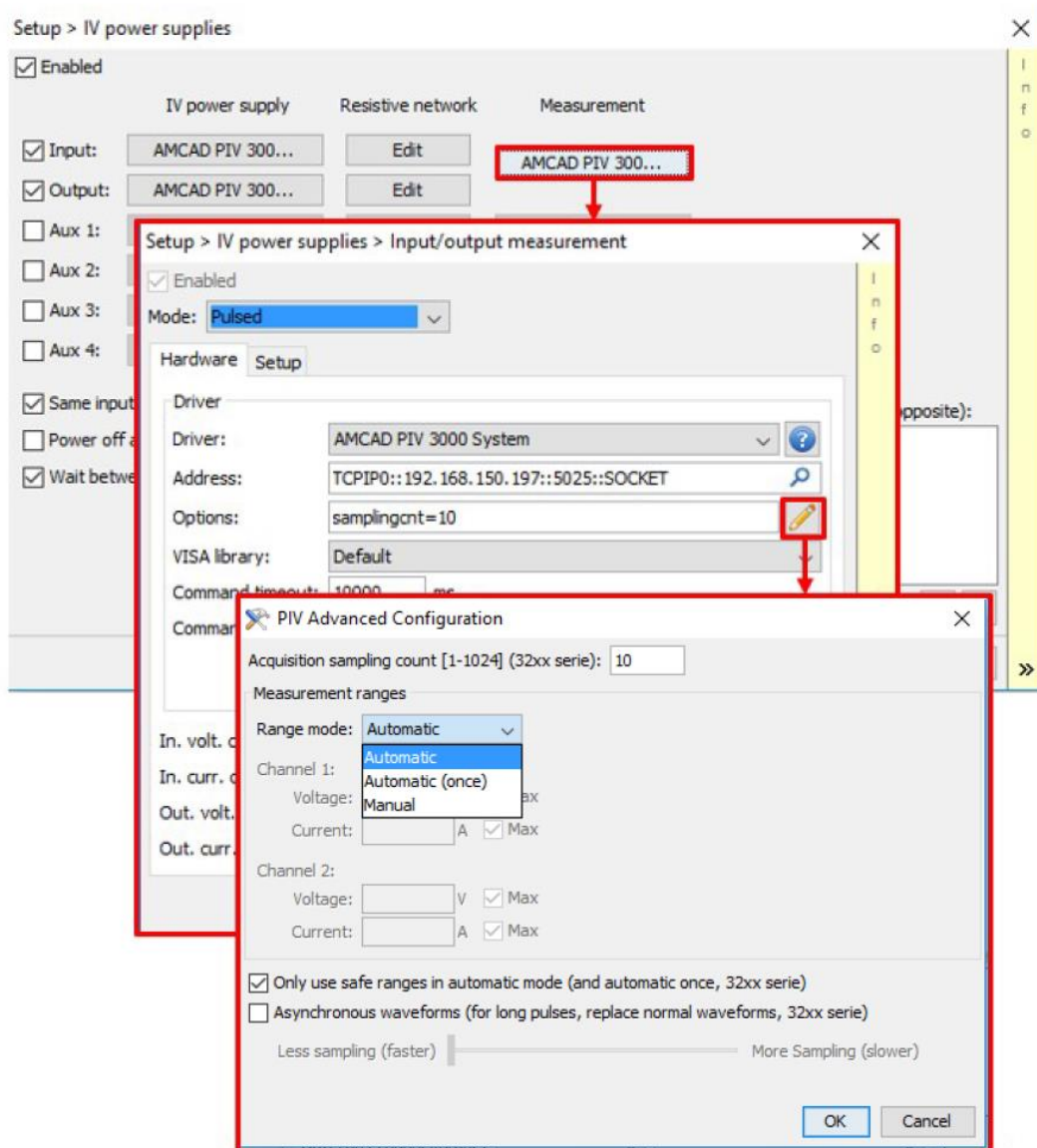

Figure 33 AM3100 Advanced options access

There are three different range modes:

- Automatic** set the appropriate range on each probes head. The range verification is done for each point of measurement.
- Automatic (once)** set the appropriate range on each probes head. The range verification isn't systematically done for each point of measurement, it depends on the parameters change (e.g. change of voltage or timing). Can improve the measurement speed.
- Manual** this mode allows to set manually the range of each probe head. As shown in the example below, user set the maximum current and voltage achievable with the DUT, in order to set the higher measurement range needed.

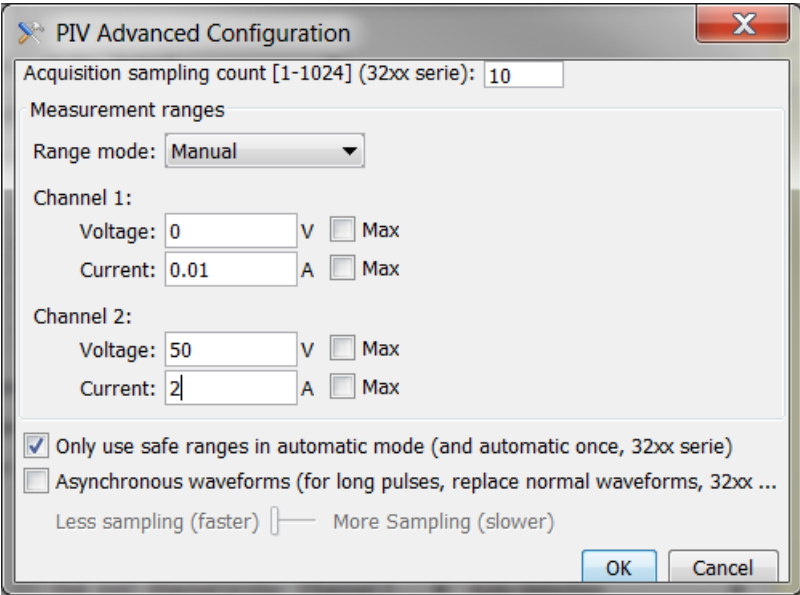

Figure 34 AM3100 manual measurement range

Contact Information

IVCAD is offered exclusively by Maury Microwave Corporation and is powered by AMCAD Engineering.

For Technical Assistance,

- Contact Maury Microwave Corp by sending an email to **IVCAD.support@maurymw.com** or calling **+1 (909) 204-3283** (Monday to Friday, 8AM to 5PM PST).
- Contact AMCAD Engineering by sending an email to **contact@amcad-engineering.com** or calling **+33 (0)555 040 531** (Monday to Friday, 09:00-17:00 CEST)

For additional information or sales assistance, please visit www.maurymw.com, email sales@maurymw.com or contact your local representative or distributor.

To learn more about AMCAD Engineering's products and services, visit www.amcad-engineering.com