

Features

- Search and capture system using Pentek's [Sentinel™ Intelligent Signal Scanner](#)
- Captures RF signals from 1 GHz to 26 GHz
- Capture and scan bandwidths up to 500 MHz
- Selectable threshold triggered or manual record modes
- 12 bit A/Ds with 57.5 dB SNR & 72 dB SFDR
- Built-in DDC with selectable decimations of 4, 8, and 16
- [Rugged](#) 1/2 ATR MIL-spec chassis for harsh mechanical and thermal environments
- [Environmentally sealed](#)
- Internally conduction-cooled
- Fully sealed for RF emissions with EMI power line filter
- MIL-STD circular connectors
- Compact and lightweight: about 23 lb (10.4 kg)
- [QuickPac® drive packs](#) allow quick removal of all data storage via the front panel
- Ideal for UAVs, military vehicles, aircraft pods and outdoor environments
- Sustained real-time record rates up to 4 GB/s
- 12 to 28 VDC power supply
- Optional GPS receiver for precise time and position stamping
- [SystemFlow GUI](#), [SystemFlow API](#), and [Signal Viewer](#) analysis tools
- Optional [telnet remote connection](#) to recorder



Overview

Pentek's Talon® RTX 2684 combines the power of a Pentek Talon Recording System with a 26 GHz RF tuner and Pentek's [Sentinel](#) intelligent signal scanning software — packaged in an extremely rugged, small form factor (SFF) 1/2 ATR chassis. Pentek's SFF recorders provide the performance of large rackmount recorders in the smallest footprint available in Pentek's Talon product line.

The RTX 2684 provides SIGINT engineers the ability to scan the RF spectrum from 1 GHz to 26 GHz for signals of interest and monitor or record bandwidths up to 500 MHz wide. A spectral scan facility allows the user to scan the spectrum, while threshold detection allows the system to automatically lock onto and record signal bands. Scan results are displayed in a [waterfall plot](#) and can also be recorded to allow users to look back at some earlier spectral activity. Once a signal of interest is detected, the real-time recorder can capture and store hundreds of terabytes of data to disk, allowing users to store data spanning many hours.



Sentinel Features

Pentek's Sentinel™ recorders add intelligent signal monitoring and detection for Talon real-time recording systems. The intuitive GUI allows users to monitor the entire spectrum or select a region of interest, while a selectable resolution bandwidth allows the user to trade sweep rate for a finer resolution and better dynamic range. Scan settings can be saved as profiles to allow for quick setup in the field.

RF energy in each band of the scan is detected and presented in a waterfall display. Any RF band can be selected for real-time monitoring or recording. In addition to manually selecting a band for recording, a recording can be automatically started by configuring signal strength threshold levels to trigger a recording.

The Sentinel hardware resources are controlled through enhancements to Talon's SystemFlow® software package that includes a virtual oscilloscope, virtual spectrum analyzer and spectrogram displays. These provide a complete suite of analysis tools to complement the Sentinel hardware resources.

RF Scanner GUI

An RF Scanner GUI allows complete control of the system through a single interface. Start and stop frequencies of a scan can be set by the user as well as the resolution bandwidth. All user parameters can be saved as profiles for easy setup in the field.

Frequency slices from the waterfall display can be selected and monitored, allowing the user to zoom into bands of interest. Threshold triggering levels can be set to record signals that exceed a specified energy. Recordings can also be manually started and stopped from the RF Scanner GUI.

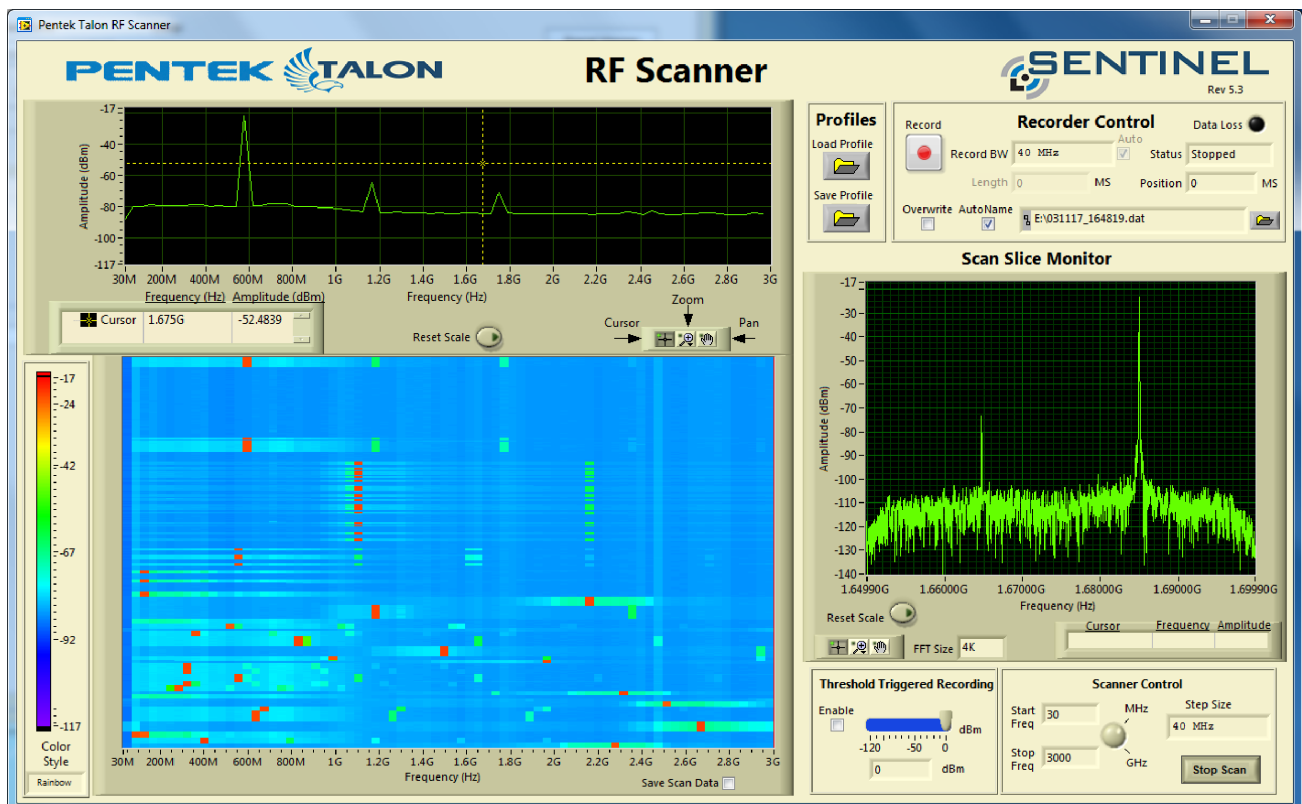

2684 Block Diagram

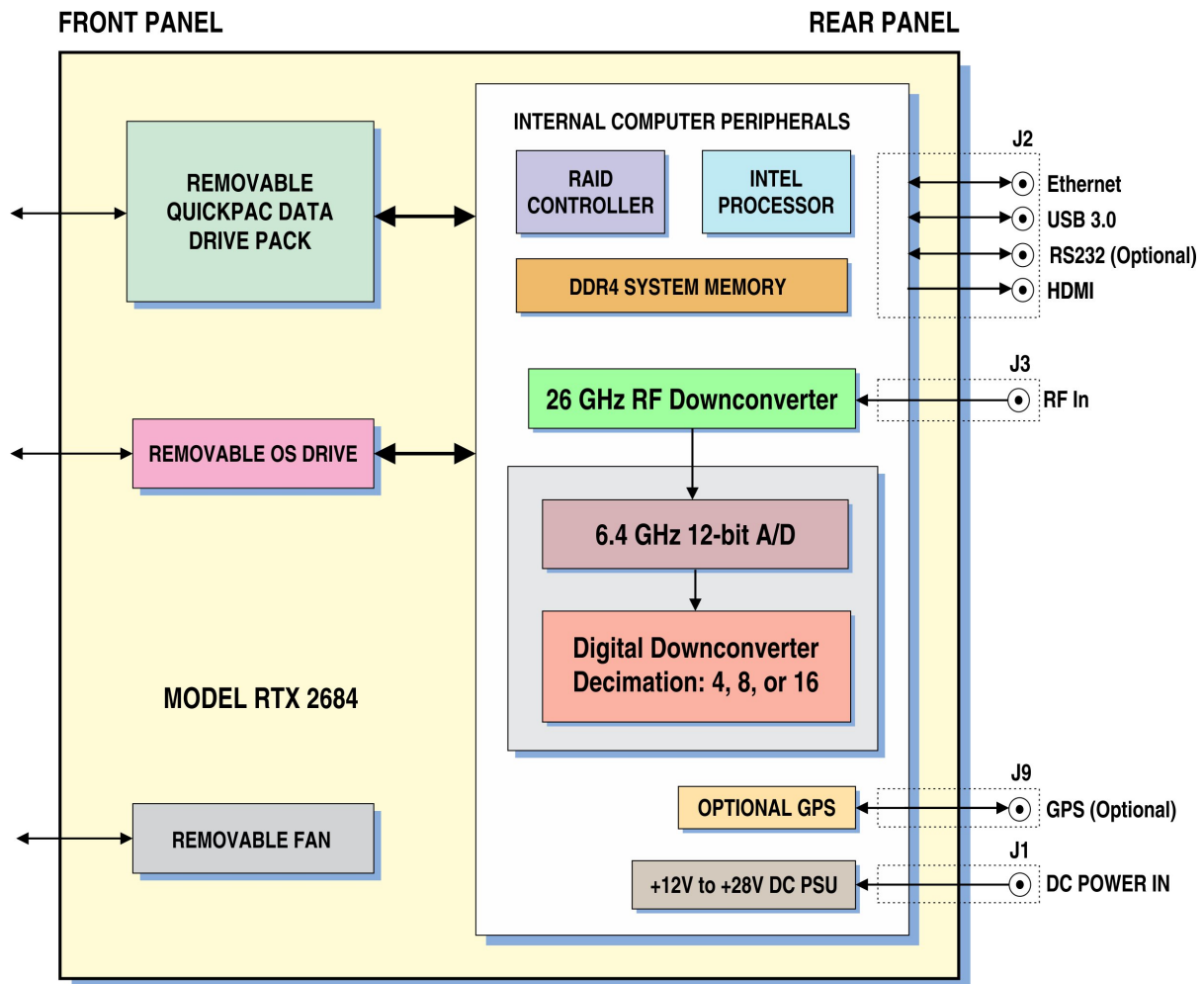

Hardware Features

The Pentek Jade[®] Model 78141A Kintex[®] UltraScale[™] board used in the RTX 2684 provides 6.4 GHz A/D converters that are used to sample the 500 MHz bandwidth of the 26 GHz tuner. The A/Ds are clocked at a 2.8 GHz sample rate and are coupled with an FPGA-based DDC with selectable decimations of 4, 8, and 16 to provide flexible bandwidth captures and improve scan resolution.

The Talon RTX 2684 is one of Pentek's Small Form Factor (SFF) recorders. Pentek's SFF recorders provide the performance of large rackmount recorders in the smallest footprint available in Pentek's Talon Recording System product line. Packaged in an extremely rugged 1/2 ATR form factor, these recorders provide high-performance processing, high-speed data storage, and large solid state storage capacity.

Optimized for SWaP (size, weight and power), Talon RTX SFF recorders are packaged in a 1/2 ATR footprint, measuring about 9.1" H x 4.880" W x 14.125" D and weighing only about 23 pounds (10.4 kg). These recorders are capable of sustained real-time recording speeds up to 4 GB/s and can hold up to 61 TB of SSD storage. A standard system will draw approximately 125 W at full operation.

Extremely Rugged Design

Designed to operate in the toughest environments, the recorder chassis keeps all electronics sealed from the outside environment and removes heat by conducting to forced-air cooling channels. Designed to operate from -40° to $+50^{\circ}$ C, these recorders can operate in most thermal environments, making them ideal for UAVs, aircraft pods, tight equipment bays, military vehicles and most outdoor environments.

The sealed $\frac{1}{2}$ ATR chassis uses MIL-STD circular connectors for I/O to control RF emissions while protecting the recorder's electronics from humidity, water, dust, sand and salt fog. In addition to meeting MIL-STD 461 specifications for radiated RF emissions, conducted emission military specifications are met by design with a built-in conducted emissions filter.

Designed to handle high levels of shock and vibration, this extremely rugged chassis supports Pentek's extensive line of I/O front-ends, providing multichannel, wide bandwidth RF recording and a variety of digital interface recording options. An optional GPS receiver provides precise time stamping of recordings and can track and record the GPS position of the system during operation.

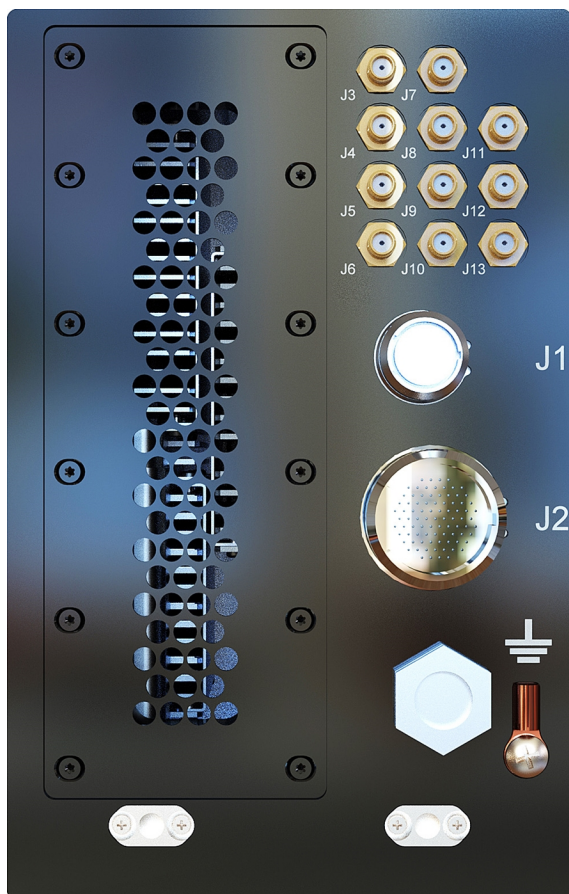

Rear Panel I/O

The Talon RTX SFF rear panel I/O provides circular connectors for power and computer I/O. Bulkhead mounted SMA connectors for RF signals, GPS, clocks and triggers are sealed with gaskets for moisture and RF emissions protection. Optical I/O is provided via an optional rear panel connection.

QuickPac Drive Packs

The Pentek QuickPac drive packs add a valuable convenience to the RTX SFF 1/2 ATR recorder by providing the ability to quickly remove all data storage from the recorder via the front panel. With up to 61 TB of solid-state data storage capacity, QuickPac drive packs can be easily removed from the recorder by loosening a set of captive thumb screws. A separate operating system drive can be removed as well, allowing users to extract all non-volatile memory from the system in just a few seconds.

QuickPac drive packs include a high insertion cycle connector to provide an extremely durable data storage drive for Talon recorders. Spare QuickPac drive packs can replace full ones in seconds to minimize mission downtime. QuickPac drive packs filled with mission data can be taken to the lab where data can be retrieved, post-processed and archived with a Talon offload system.

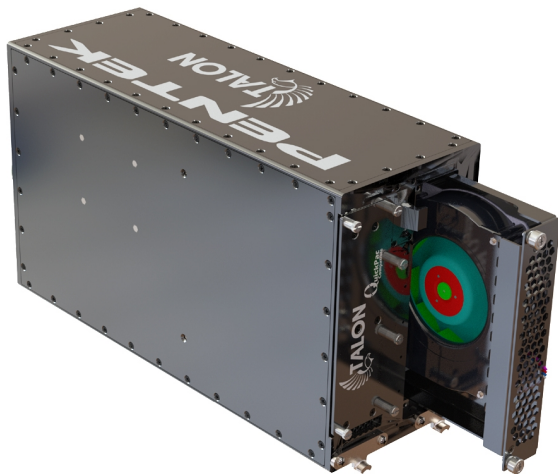

Sealed Chassis with Cooling Design

The Talon RTX SFF chassis seals the internal electronics from the outside environment by providing an inner plenum that is designed to extract heat from the internal electronics via conduction. The plenum is supplemented by a removable fan that is used to pull air from the front of the chassis and exhaust it through the rear. Only the fan is exposed to the outside environment, assuring the electronics are protected in the sealed chassis. The removable fan pulls air from the front of the chassis across heat sinks that are welded to the inner plenum of the chassis.

The welded heat sinks are attached directly to all heat-generating electronics within the sealed chassis, providing a conduction-cooled path to the inner plenum. This assures optimal cooling while maintaining a sealed design. The inner plenum can be replaced to provide other cooling options, such as liquid or conduction cooling.

SystemFlow Overview

All Talon recorders include the Pentek SystemFlow[®] recording software. SystemFlow software provides three ways for users to configure and control a Talon recorder:

- The **SystemFlow GUI** provides an easy out-of-the-box experience which allows the operator to open the box and begin recording with a point and click user interface.
- The **SystemFlow API** provides a set of C-callable libraries that allow engineers to develop their own user interface to configure and control their Talon recorder.
- The **SystemFlow Telnet** interface provides a simple set of commands to configure and control the recorder. This eliminates the need for any software development and is most suitable for unmanned operation.

SystemFlow software allows the recorder to be set up to run autonomously by implementing scripts using the API or telnet interface. All three interfaces can be run from a remote connection over Gigabit Ethernet and all allow for easy access to recorded files.

SystemFlow GUI

The SystemFlow GUI shows a block diagram of the system and provides the user with a control interface for the recording system. It includes Configure, Record, Playback, and Status screens, each with intuitive controls and indicators. The user can easily move between screens to configure parameters, control and monitor a recording, and play back a recorded stream.

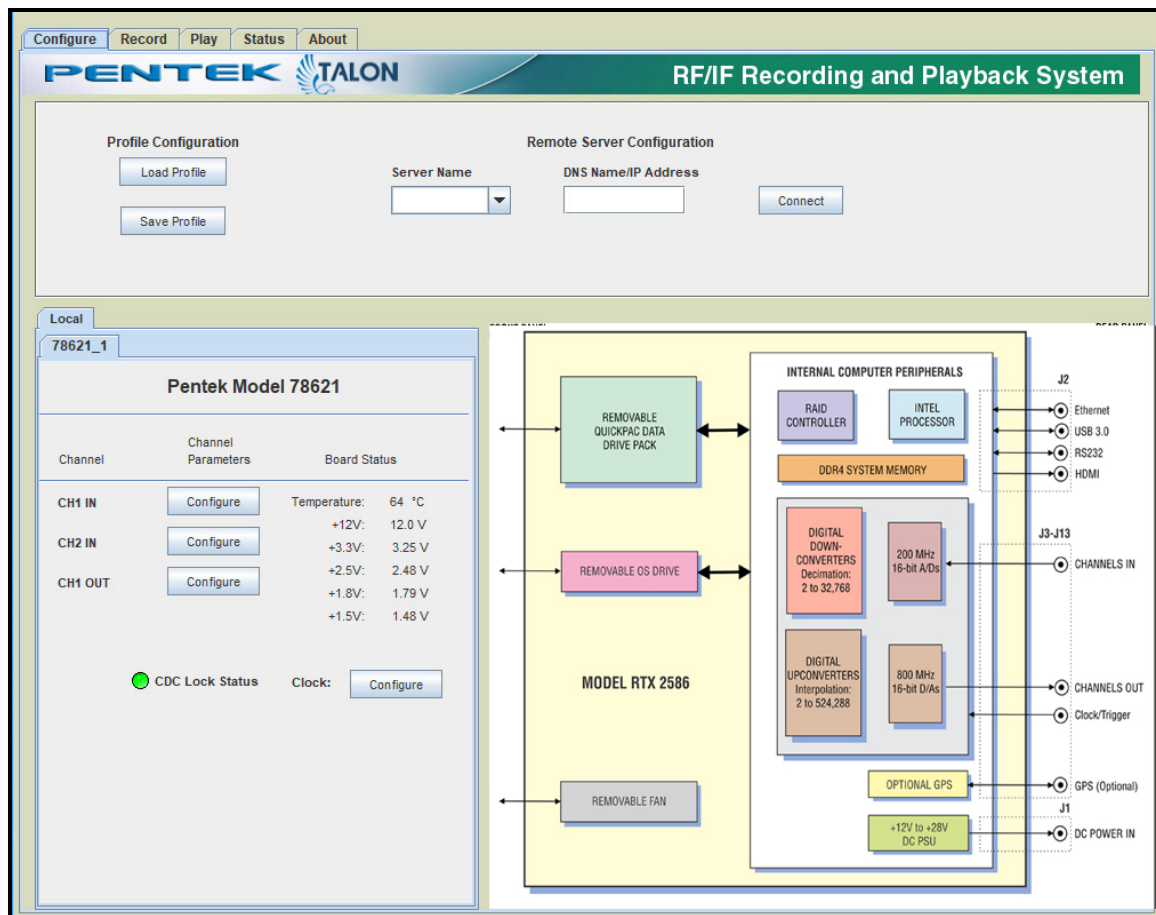

SystemFlow API

SystemFlow includes a complete API (Application Programming Interface) supporting control and status queries of all operations of the Talon recorder from a custom application.

High-level C-language function calls and the supporting device drivers allow users to incorporate the RTX 2684 as a high-performance server front end to a larger system. This is supported using a socket interface through the Ethernet port, either to a local host or through an internet link for remote, standalone acquisition. Recorded NTFS files can be easily retrieved through the same connection.

Below is an example of controlling recording via the SystemFlow API.

```

728     }
729     //transfer until end of disk
730     else if (transferType == TRANSFER_END_OF_DISK)
731     {
732         recordParams->transferTime    = 0;           // must set to 0
733         recordParams->transferLength  = 0;           // must set to 0
734     }
735
736     //////////////////////////////////////////////////////////////////// Start the record ////////////////////////////////////////////////////////////////////
737     SetConsoleTextAttribute (hConsole, FOREGROUND_GREEN | FOREGROUND_INTENSITY );
738     printf("\nCase 6: RTS_Record\n");
739     SetConsoleTextAttribute (hConsole, wOldColorAttrs);
740
741     //trigger immediately
742     if(recordParams->trigger == RTS_TRIGGER_IMMEDIATELY)
743     {
744         //send record command
745         if ((error = RTS_Record(++msgNum,
746                               serverInfo,
747                               recordParams,
748                               recordChanId,
749                               fileName[0])) != RTS_SUCCESS)
750         {
751             printf("Record Error # 0x%lx.\n", error);
752             exitHandler(error);
753             goto freeMem;
754         }
755
756         Sleep(500);
757     }
758
759     //wait for SW trigger
760     else if(recordParams->trigger == RTS_WAIT_FOR_SW_TRIGGER)
761     {
762         //send record command which set up record and start DMA
763         if ((error = RTS_Record(++msgNum,
764                               serverInfo,
765                               recordParams,
766                               recordChanId,
767                               fileName[0])) != RTS_SUCCESS)

```

SystemFlow Telnet

The Talon telnet facility is an optional feature that can be requested when ordering one of Pentek's Talon recording systems. The Talon telnet facility allows you to control a Talon recorder from a remote computer. You also can use the Talon recorder's SystemFlow [Signal Viewer](#) to remotely monitor real-time data.

Pentek's [Telnet Facility for Talon Recording Systems User's Guide](#) provides instructions for setting up telnet access and describes all the supported commands.

Below is an example of use of the "record" command:

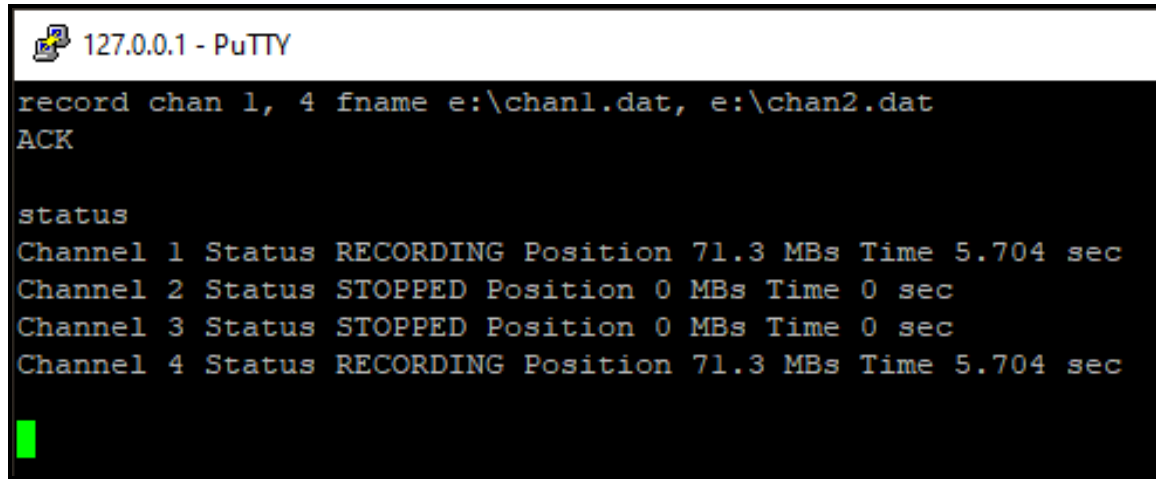

```
127.0.0.1 - PuTTY
record chan 1, 4 fname e:\chan1.dat, e:\chan2.dat
ACK

status
Channel 1 Status RECORDING Position 71.3 MBs Time 5.704 sec
Channel 2 Status STOPPED Position 0 MBs Time 0 sec
Channel 3 Status STOPPED Position 0 MBs Time 0 sec
Channel 4 Status RECORDING Position 71.3 MBs Time 5.704 sec
```

Signal Viewer

The SystemFlow Signal Viewer includes a virtual oscilloscope and spectrum analyzer for signal monitoring in both the time and frequency domains. It is extremely useful for previewing live inputs prior to recording, and for monitoring signals as they are being recorded to help ensure successful recording sessions. The viewer can also be used to inspect and analyze the recorded files after the recording is complete.

Advanced signal analysis capabilities include automatic calculators for signal amplitude and frequency, second and third harmonic components, THD (total harmonic distortion), and SINAD (signal to noise and distortion). With time and frequency zoom, panning modes, and dual, annotated cursors to mark and measure points of interest, the SystemFlow Signal Viewer can often eliminate the need for a separate oscilloscope or spectrum analyzer in the field.

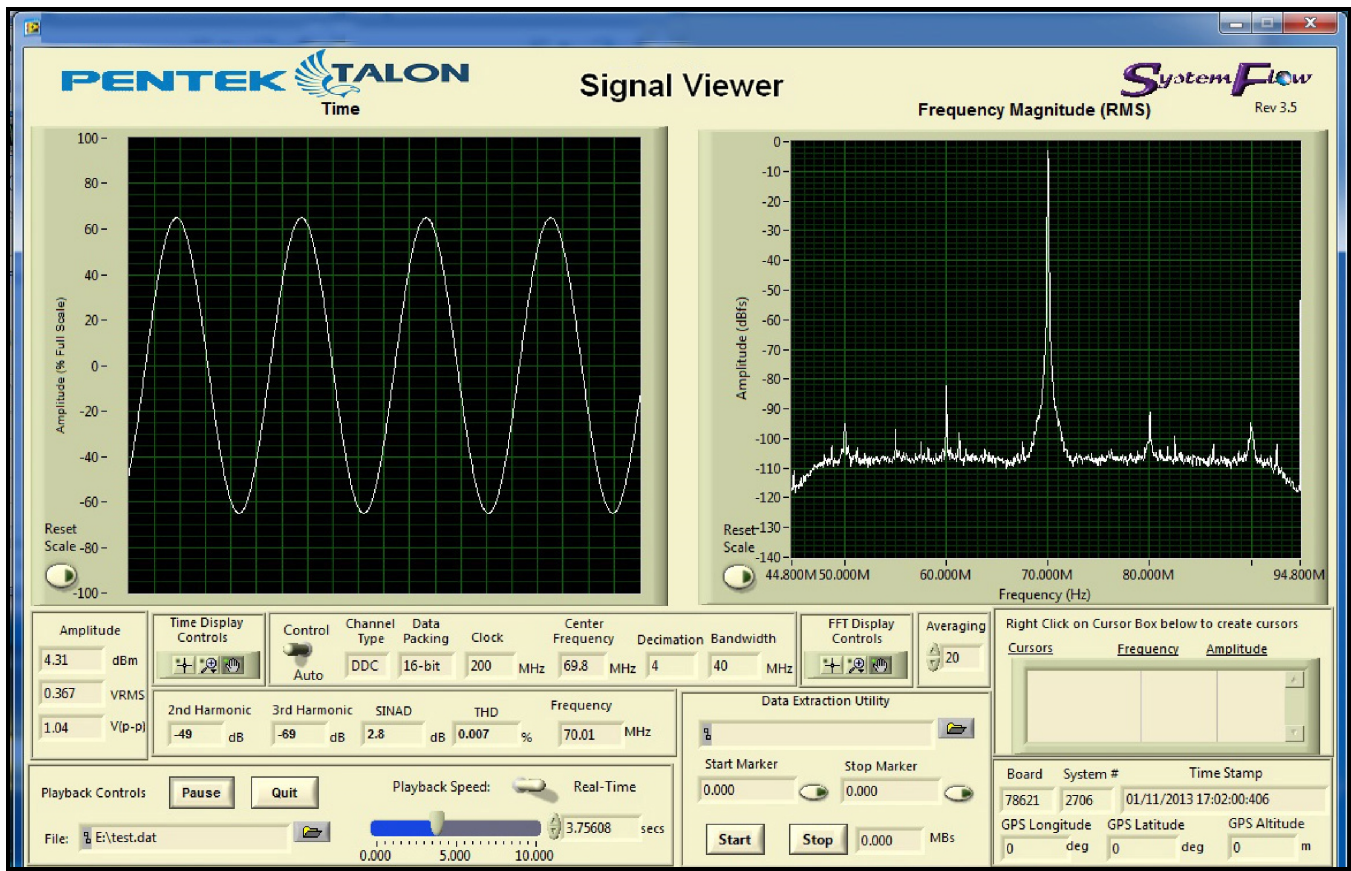

Specifications

RF Tuner

Receiver Analog:

Frequency Range: 1 GHz to 26 GHz

Tuning Resolution: 1 kHz steps

Internal Frequency Accuracy: ± 1.0 ppm (-20 to +60°C), options available

External Reference Input Frequency: 10 MHz

External Reference Input Level: 0 dBm ± 3 dBm

RF input: 50 ohms nominal

VSWR: 3:1 max., <2.0:1 typical at tuned frequency

Preselection: 9 suboctave fixed bands <9.5 GHz; 2 tracking filters >9.5 GHz

Noise figure (measured at 30 dB Gain): 14 dB typical, 16 dB maximum, 1 to 26 GHz

Maximum RF input without damage: +10 dBm

In-Band Input Third-Order Intercept Point: +0 dBm typical, -10 dBm min

Input Second-Order Intercept Point: +30 dBm min, +40 dBm typical

IF center frequency: 1000 MHz (other options available)

IF bandwidth (-3dB): 500/250/125 MHz nom. (user selectable)

Gain: +60 dB nominal above RF input

Gain control (selectable): Manual 60 dB range nom.; AGC, ± 3 dB nom. For output levels -20 to 0 dBm

Image rejection: 60 dB min (>70 dB typical)

IF rejection: 65 dB min (>80 dB typical)

LO Level at RF Input: -75 dBm maximum (<-85 dBm typical)

Integrated Phase Jitter (10KHz to 10MHz): 0.5* rms typical (<18GHz), 0.9* rms typical (>18GHz)

Tuner Tuning Speed (Random Step): 100 usec typical, 800usec max. to within 1 KHz

Tuner Tuning Speed (F1-F2 Scan): 50usec typical, 200usec max. , to within 1 KHz (F2>F1, NT-118)

Internally Generated Spurious: -100 dBm equivalent RF input typical

Single Tone Spurious (-40 dBm RF Input Level): -50dBc max. (<-60dBc typical)

A/D Converter

Type: Texas Instruments ADC12DJ3200

Sampling Rate: Up to 3200 MHz

Resolution: 12 bits

SNR: 57.5 dB f_s typical at 1 GHz

SFDR: -72 dB f_s typical at 1 GHz

2nd Harmonic: -72 dB f_s typical at 1 GHz

3rd Harmonic: -72 dB f_s typical at 1 GHz

SINAD: 55.7 dB f_s typical at 1 GHz

ENOB: 9 bits typical at 1 GHz

Integrated DDC: Selectable decimations of 4, 8 and 16

Physical Characteristics

Dimension: 9.1" H x 4.880" W x 14.125" D (231 mm H x 124 mm W x 359 mm D)

Weight: 18 lb (8 kg)

Storage: One removable QuickPac drive pack with up to 61 TB total storage

RAID Levels: 0, 5 and 6 available

One removable Operating System SSD (M.2 form factor - 250 GB standard)

Front Panel I/O

One removable QuickPac drive pack (Thumbscrew removable)

One removable Operating System SSD (Thumbscrew removable)

One removable System Fan (Thumbscrew removable)

Rear Panel I/O

Chassis power connector: Glenair 805-005-07M12-2PA

Mating cable power connector: Glenair 805-002-16M12-2SA

Computer I/O

Chassis Computer I/O Connector: Glenair 805-003-07M19-85SA

Signals, 1 each: HDMI, USB 3.0, Ethernet (RJ 45), RS232 (optional)

Mating cable computer I/O Connector: Glenair 802-002-16M19-85PA

RF: 11x SMA (female SMA bulkhead-mounted with gaskets)

Cooling

Conduction-cooled to inner air channel

Removable fan inserted in air channel to pull air across sealed heat sinks

Optional direct conduction cooling and other methods available

Power

+12 to +28 VDC (+24 VDC nominal) 125 Watts power consumption typical, 170 W maximum

Environmental

Operating Temp: -40° to +50° C (-20° C start-up)

Storage Temp: -65° to +85° C

Altitude: 60,000 feet

Relative Humidity: 5 to 95%, condensing

Vibration: MIL-STD-810 Method 514.5

Shock: MIL-STD-810 Method 516.5

EMI/EMC: MIL-STD-461 - CE101, CE102, CS101, RE101, RE102, RS101

Sand and Dust: MIL-STD-810 Method 510

Specifications are subject to change without notice.

Ordering Information

Click [here](#) for more information.

Storage Options	
Option -410	3.84 TB SSD storage capacity
Option -415	7.68 TB SSD storage capacity
Option -420	15.36 TB SSD storage capacity
Option -430	30.72 TB SSD storage capacity
Option -460	61 TB SSD storage capacity
RAID Configurations	
Standard	RAID Level 0
Option -285	RAID Level 5
Option -286	RAID Level 6
Additional Options	
Option -261	GPS time and position stamping
Standard	8 GB DDR System Memory
Option -309	16 GB DDR System Memory
Option -310	32 GB System Memory
Contact Pentek for compatible Option combinations. Storage and General Options may change, contact Pentek for latest information.	

Pricing and Availability

To learn more about our products or to discuss your specific application please contact [your local representative](#) or Pentek directly:

Pentek, Inc.
 One Park Way
 Upper Saddle River, NJ 07458 USA
 Tel: +1 (201) 818-5900
 Email: sales@pentek.com

Lifetime Support

Pentek offers the worldwide military embedded computing community shorter development time, reliable, rugged solutions for a variety of environments, reduced costs, mature software development tools, and **free** lifetime support that our customers can depend on: phone and email access to engineering staff as well as software updates. Take advantage of Pentek's expertise in delivering high-performance radar, communications, SIGINT, and data acquisition MIL-Aero solutions worldwide for over 30 years.