

Digital I/O board, optically isolated, 16 digital inputs and outputs, 24 V

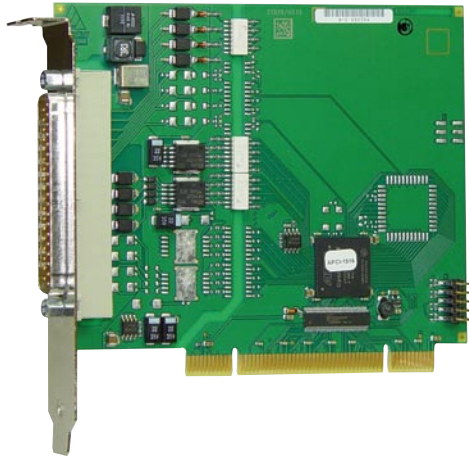

APCI-1516

8 digital inputs, 24 V

8 digital outputs, 24 V, 500 mA/channel

Optical isolation 1000 V

Input and output filters

Watchdog



PCI 32-bit

Also for
PCI EXPRESS see
page 80



Signed 64-bit drivers
for Windows 7/Vista/XP



LabVIEW™



LabWindows/CVI™

DASYLab10
Data Acquisition System Laboratory



Features

Inputs

- 8 optically isolated inputs, 24 V
- Reverse voltage protection
- All inputs are filtered

Outputs

- 8 optically isolated outputs, 10 V to 36 V
- Output current per channel 500 mA
- Total current: 3 A typ. (fused through PTC resistor)
- Watchdog for resetting the outputs to "0"
- At Power-On, reset of the outputs to "0"
- Short-circuit current for 8 outputs ~ 3 A typ.
- Short-circuit current per output ~1.5 A typ.
- Self-resetting fuse (electronic fuse)
- Overtemperature and overvoltage protection
- 24 V power outputs with protection diodes and filters
- Output capacitors against electromagnetic emissions
- External 24 V voltage supply screened and filtered
- Shutdown logic, when the external supply voltage drops below 5 V
- Diagnostic function for detecting short-circuits and overtemperature

Safety features

- Optical isolation 1000 V
- Creeping distance IEC 61010-1
- Separate ground lines for inputs and outputs
- Protection against fast transients (burst), overvoltage, electrostatic discharge and high-frequency EMI

Protective circuit for the input channels

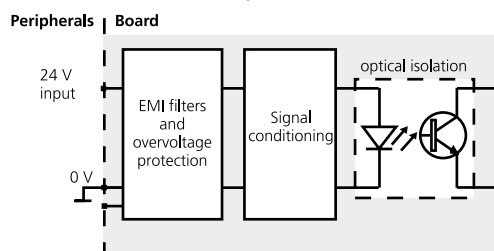

Applications

- Industrial I/O control
- PLC coupling
- Signal switching
- Interface to electromechanical relays
- Automatic test equipment
- ON/OFF monitoring of motors, lights...
- Watchdog
- Machine interfacing

Software drivers

A CD-ROM with the following software and programming samples is supplied with the board.

Standard drivers for:

- Linux
- 32-bit drivers for Windows 8 / 7 / Vista / XP / 2000
- Signed 64-bit drivers for Windows 8 / 7 / XP
- Real-time use with Linux and Windows on request

Drivers and samples for the following compilers and software packages:

- .NET
- Microsoft VC++ • Borland C++
- Visual Basic • Delphi
- LabVIEW • LabWindows/CVI • DIAdem

ADDIPACK functions:

- Digital input • Digital output • Watchdog

On request:

Further operating systems, compilers and samples.

Driver download: www.addi-data.com/downloads

Protective circuit for the output channels

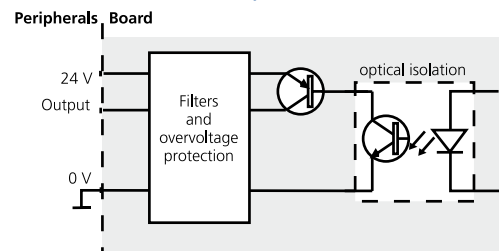

Specifications

Digital inputs

Number of inputs:	8 (common ground acc. to IEC 1131-2)
Nominal voltage:	24 V
Input current at 24 V:	6 mA typ.
Logic input levels:	
U nominal:	24 V
UH max.:	30 V/current 9 mA typ.
UH min.:	19 V/current 2 mA typ.
UL max.:	14 V/current 0.6 mA typ.
UL min.:	0 V/current 0 mA typ.
Optical isolation:	Through opto-couplers, 1000 V from PC to peripheral
Signal delay:	70 µs (at 24 V)
Maximal input frequency:	5 kHz (at 24 V)

Digital outputs

Number of outputs:	8, optically isolated up to 1000 V through opto-couplers
Output type:	High side (load to ground) acc. to IEC 1131-2
Nominal voltage:	24 V
Supply voltage:	10 V to 36 V, min. 5 V (via front connector)
Max. current for 8 outputs:	3 A typ.
Output current/output:	500 mA max.
Short-circuit current/output shutdown at 24 V, $R_{load} < 0.1 \Omega$:	1.5 A
RDS ON resistance:	0.4 Ω max.
Switch-on time:	I out=0.5 A, load = resistance: 100 µs
Switch-off time:	I out=0.5 A, load = resistance: 60 µs
Overtemperature (shutdown):	170 °C (output driver)
Temperature hysteresis:	20 °C (output driver)

Safety

Shutdown logic:	When the ext. 24 V voltage drops below 5 V: The outputs are switched off.
Diagnostics (pin 19)	Diagnostics at output overload and overtemperature
Watchdog:	Timer-programmable 20 ms to 5 s in steps of 20 ms

EMC – Electromagnetic compatibility

The product complies with the European EMC directive. The tests were carried out by a certified EMC laboratory in accordance with the norm from the EN 61326 series (IEC 61326). The limit values as set out by the European EMC directive for an industrial environment are complied with. The respective EMC test report is available on request.

Physical and environmental conditions

Dimensions:	131x 99 mm
System bus:	PCI 32-bit 3.3/5 V acc. to specification 2.1 (PCISIG)
Space required:	1 PCI slot
Operating voltage:	+5 V, ± 5 % from the PC
Current consumption:	210 mA ±10 % typ.
Front connector:	37-pin D-Sub male connector
Temperature range:	0 to 60 °C (with forced cooling)

Simplified block diagram

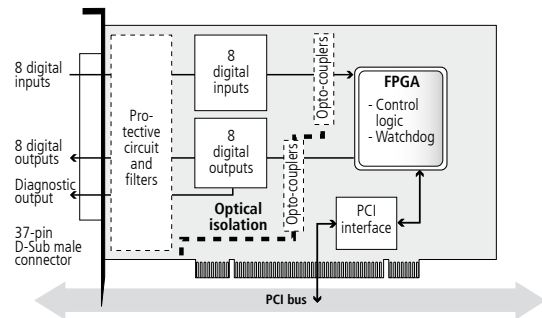

Pin assignment – 37-pin D-Sub male connector

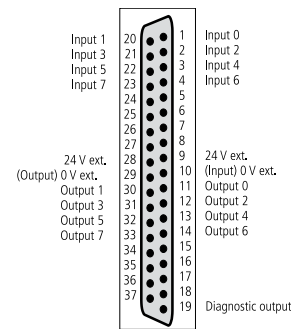

ADDI-DATA connection

Example 1

Connection of the inputs and outputs through screw terminal panels

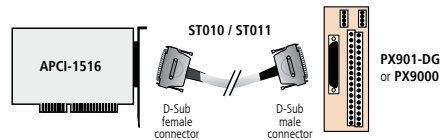

Example 2

- Connection of the inputs through screw terminal panel PX901-DG
- Connection of the outputs through relay output board PX8500-G

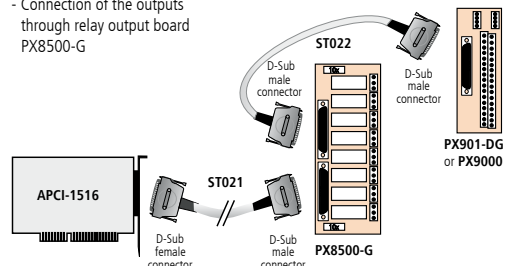

Ordering information

APCI-1516

Digital I/O board, optically isolated, 16 digital inputs and outputs, 24 V. Incl. technical description, software drivers

Accessories

PX901-D:	Screw terminal panel, LED status display
PX901-DG:	Screw terminal panel, LED status display, for DIN rail
PX9000:	3-row screw terminal panel for DIN rail, with LED status display
PX8500-G:	Relay output board for DIN rail, cascadable

ST010:	Standard round cable, shielded, twisted pairs, 2 m
ST011:	Standard round cable, shielded, twisted pairs, 5 m
ST010-S:	Same as ST010, for high currents
ST021:	Round cable between APCI-1516 and PX8500-G, shielded, twisted pairs, 2 m
ST022:	Round cable between PX8500-G and PX 901 or PX9000, shielded, 2 m
ST8500:	Ribbon cable for cascading two PX 8500