

New!



Features

- Synchronizes up to four separate high-speed Cobalt or Onyx I/O boards
- Synchronizes sampling and data acquisition for multichannel systems
- Synchronizes gating and triggering functions
- Clock rates up to 1.8 GHz
- Front panel MMCX connectors for input signals
- Front panel μ Sync connectors compatible with a range of Pentek Cobalt and Onyx boards

General Information

The Model 7892 High-Speed Synchronizer and Distribution PCIe Board synchronizes multiple Pentek Cobalt or Onyx boards within a system. It enables synchronous sampling and timing for a wide range of multichannel high-speed data acquisition, DSP, and software radio applications.

Up to four boards can be synchronized using the 7892, with each receiving a common clock along with timing signals that can be used for synchronizing, triggering and gating functions.

Input Signals

Model 7892 provides three front panel MMCX connectors to accept input signals from external sources: one for clock, one for gate or trigger and one for a synchronization signal. Clock signals can be applied from an external source such as a high performance sine-wave generator. Gate/trigger and sync signals can come from an external system source. In addition to the MMCX connector, a reference clock can be accepted through the first front panel μ Sync output connector, allowing a single Cobalt or Onyx board to generate the clock for all subsequent boards in the system.

Output Signals

The 7892 provides four front panel μ Sync output connectors, compatible with a range of high-speed Pentek Cobalt and

Onyx boards. The μ Sync signals include a reference clock, gate/trigger and sync signals and are distributed through matched cables, simplifying system design.

Clock Signals

The 7892 can accept a user supplied external clock on its front panel MMCX connector. As an alternative to the external clock, the 7892 can use its on-board programmable voltage controlled crystal oscillator (VCXO) as the clock source. The VCXO can operate alone or be locked to a system reference clock signal delivered to the front panel reference clock input.

The external or on-board clock can operate at full rate or be divided and is used to register all sync and gate/trigger signals as well as providing a reference clock to all connected boards. In addition, the clock is available at the Clock Out MMCX as a sample or reference clock for other boards in the system.

Gate and Synchronization Signals

The 7892 features separate inputs for gate/trigger and sync signals. A programmable delay allows the user to make timing adjustments on the gate/trigger and sync signals before they are sent to buffers for output through the μ Sync output connectors. ➤

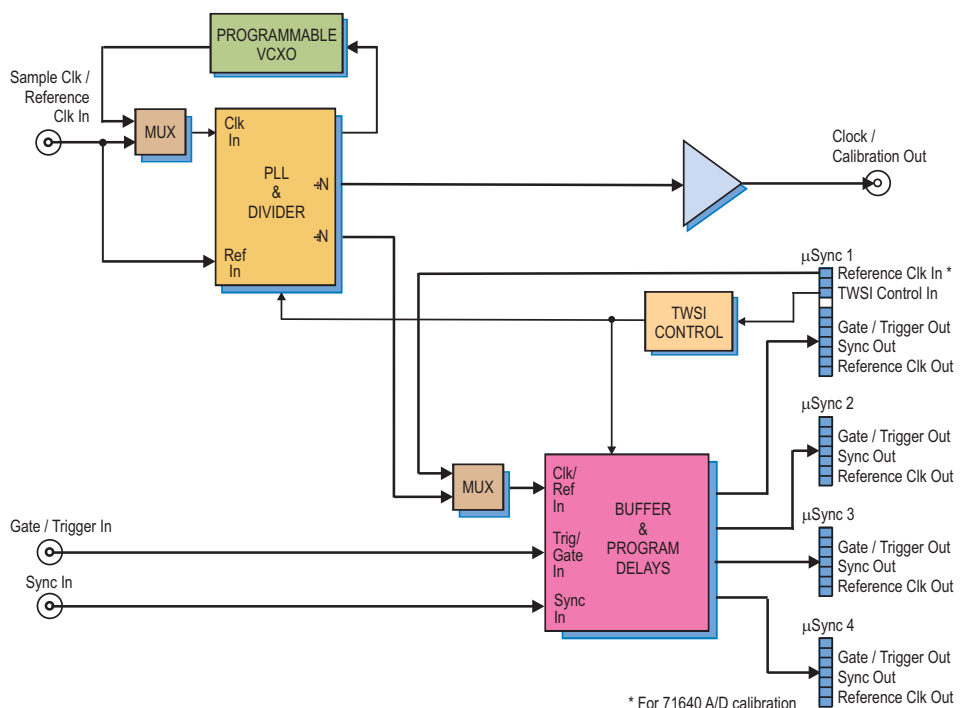

Calibration

The 7892 features a calibration output specifically designed to work with the 78640 or 78740 3.6 GHz A/D board and provide a signal reference for phase adjustment across multiple D/As.

Programming

The 7892 allows programming of operating parameters including: VCXO frequency, clock dividers, and delays that allow the user to make timing adjustments on the gate and sync signals. These adjustments are made before they are sent to buffers for output through the μ Sync connectors.

The 7892 is programmed via a TWSI control interface on the first μ Sync connector. The control interface is compatible with the front panel μ Sync connectors of all high-speed Cobalt and Onyx boards, thereby providing a single cable connection that carries both control and timing signals.

Supported Products

The 7892 supports all high-speed models in the Cobalt family including the 78630 1 GHz A/D and D/A x8 PCIe, the 78640 3.6 GHz A/D x8 PCIe and the 78670 Four-channel 1.25 GHz, 16-bit D/A x8 PCIe. The 7892 will also support high-speed models in the Onyx family as they become available.

Specifications

Front Panel Sample Clock/Reference Input

Connector Type: MMCX

Input Impedance: 50 ohms

Input Level: 0 dBm to +10 dBm, sine wave

Sample Clock Frequency: 100 MHz to 2 GHz

Reference Frequency: 5 to 100 MHz

Front Panel Gate/Trigger & Sync Inputs

Connector Type: MMCX

Input Level: LVTTTL

Front Panel μ Sync Inputs/Outputs

Quantity: 4

Connector Type: 19-pin μ HDMI

Signal Level: CML

Signals (μ Sync connector 1): Reference Clock In, TWSI control In, Reference

Clock Out, Gate/Trigger Out, Sync Out

Signals (μ Sync connectors 2-4): Reference Clock Out, Gate/Trigger Out, Sync

Out

Front Panel Clock / Calibration Output

Connector Type: MMCX

Output Impedance: 50 ohms

Output Level: +6 dBm nominal, sine wave

Sample Clock Frequency: 100 MHz to 1.8 GHz

Programmable VCXO:

Frequency Ranges: 10-945 MHz, 970-1134 MHz, and 1213-1417.5 MHz

Tuning Resolution: 32 bits

Unlocked Accuracy: ± 20 ppm

PLL, Divider & Jitter Cleaner

Type: Texas Instruments CDCM7005

Frequency Dividers: 1, 2, 3, 4, 6, 8 and 16

PCI Express Interface

PCIe Bus: x4 or x8, power only

Environmental

Operating Temp: 0° to 50° C

Storage Temp: -20° to 90° C

Relative Humidity: 0 to 95%, non-cond.

Size: Half length PCIe card, 4.38 in. x 7.13 in.

Ordering Information

Model	Description
7892	High-Speed Synchronizer and Distribution Board - PCIe

Accessories

4 ea. 18" μ Sync cables are supplied; additional cables may be ordered:

2892-018 μ Sync cable - 18"

2892-036 μ Sync cable - 36"