

*New!*



**Features**

- Complete software radio interface solution
- PCI Express 2.0 (Gen. 2) Interface up to x8 wide
- Built-in fan for added cooling
- 32 channels of DDC in banks of 8 channels
- Independent 32-bit DDC tuning for all channels
- DDC decimation from 16 to 8192 in steps of 8
- Bandwidths from 20 kHz to 10 MHz
- Different decimation factors between banks
- User-programmable 18-bit FIR filter coefficients
- Default filters offer 0.2 dB ripple and 100 dB rejection
- Power meters and threshold detectors
- LVPECL clock/sync bus for multimodule synchronization

**General Information**

Model 7852 is a high-speed software radio module designed for processing baseband RF or IF signals from a communications receiver. It features four 200 MHz 16-bit A/Ds. The A/Ds are supported by a high-performance 32-channel installed DDC (digital downconverter) IP Core, and interfaces ideally matched to the requirements of real-time software radio and radar systems.

The 7852 attaches to motherboards with half-length PCI Express (PCIe) interface slots for installation in various PCs, blade servers and computer systems.

**A/D Converter Stage**

The front end accepts four full-scale analog RF or IF inputs on front panel SMC connectors at +8 dBm into 50 ohms with transformer coupling into four Texas Instruments ADS5485 200 MHz, 16-bit A/D converters. The digital outputs are delivered into a Xilinx Virtex-5 FPGA for routing, formatting and DDC signal processing.

**DDC Input Selection and Tuning**

The Model 7852 SX95T FPGA employs an advanced FPGA-based digital down-converter engine consisting of four identical 8-channel DDC banks. Four independently controllable input multiplexers select one of the four attached A/Ds as the input source for each DDC bank. In this way, many different configurations can be achieved including one A/D driving all 32 DDC channels and each of the four A/Ds driving its own DDC bank.

Each of the DDCs has an independent 32-bit tuning frequency setting ranging from DC to  $f_s$  ( $f_s$  is the A/D sample rate).

**Decimation and Filtering**

All of the eight channels within a bank share a common decimation setting that can range from 16 to 8192, programmable in steps of 8. For example, with a sampling rate of 200 MHz, the available output bandwidths range from 19.53 kHz to 10.0 MHz. Each 8-channel bank can have a unique decimation setting supporting up to four different output bandwidths for the board.

The decimating filter for each DDC bank accepts a unique set of user-supplied 18-bit coefficients. The 80% default filters deliver an output bandwidth of  $0.8 \cdot f_s / N$ , where N is the decimation setting. Rejection of adjacent-band components within the 80% bandwidth is better than 100 dB.

Each DDC delivers a complex output stream consisting of 24-bit I + 24-bit Q samples at a rate of  $f_s / N$ . Any number of channels can be enabled with each bank, selectable from 0 to 8. Each bank includes an output sample interleaver that delivers a channel-multiplexed stream for all enabled channels within the bank.

**Power Meters and Threshold Detectors**

The 7852 features 32 power meters that continuously measure the individual average power output of each DDC channel. The time constant of the averaging interval for each meter is programmable up to 16 kilosamples. In addition, threshold detectors automatically send an interrupt to the processor if the average power level of any DDC falls below or exceeds a programmable threshold. ▶

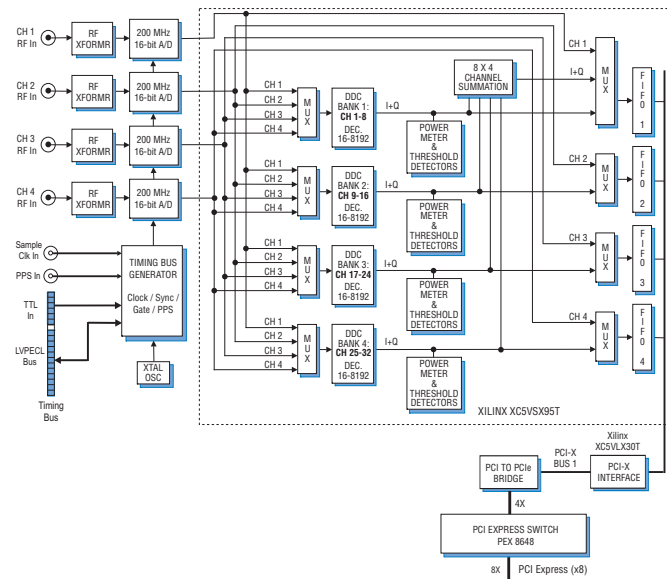

### ► Output Multiplexers and FIFOs

Four output MUXs in the SX95T FPGA can be independently switched to deliver either A/D data or DDC data into each of the four output FIFOs. This allows users to view either the wideband A/D data or the narrowband DDC data, depending on the application.

Each of the output FIFOs operates at its own input rate and output rate to support different DDC decimation settings between the banks and efficient block transfers to the PCI bus.

### Clocking and Synchronization

The Model 7852 architecture includes a flexible timing and synchronization circuit for the group of four A/D converters that allows the A/Ds to be clocked by internal or external clock sources and a multiboard timing bus.

The timing bus includes a clock, a sync, two gate or trigger signals and a PPS signal. The timing bus can be driven by an internal crystal oscillator, a front panel reference input or the LVPECL bus.

A front panel 26-pin LVPECL Clock/Sync connector allows multiple modules to be synchronized. In the slave mode, each accepts differential LVPECL inputs that drive the clock, sync, gate and PPS signals for the internal timing bus.

In the master mode, the LVPECL bus can drive the timing signals for synchronizing multiple modules. Up to three slave 7852s can be driven from each LVPECL bus master, supporting synchronous sampling and sync functions across all connected modules. For larger systems, many more modules can be synchronized with an external clock and sync generator.

### PCI Express Interface

The 7852 includes a multiple port, 48-lane Gen. 2 PCI Express (PCIe) switch with integrated SerDes. The switch provides x8 wide connection to the PCIe interface, allowing high-speed data transfers to and from the motherboard. Switch ports each include buffer memory to minimize bottlenecks, with one 4X connection provided to the 64-bit PCI-X interface.

### Specifications

#### Front Panel Analog Signal Inputs

**Input Type:** Transformer-coupled, front panel female SMC connectors

**Transformer Type:** Coil Craft WBC1-1TLB

**Full Scale Input:** +8 dBm into 50 ohms

**3 dB Passband:** 250 kHz to 350 MHz

#### A/D Converters

**Type:** Texas Instruments ADS5485

**Sampling Rate:** 10 MHz to 200 MHz

**Internal Clock:** 200 MHz crystal osc.

**External Clock:** 10 to 200 MHz

**Resolution:** 16 bits

**A/D Data Reduction Mode:** Data from the A/Ds can be decimated by any value between 1 and 4096

**Clock Sources:** Selectable from onboard crystal oscillators, external or LVPECL clocks

#### External Clock

**Type:** Front panel female SMC connector, sine wave, 0 to +10 dBm, AC-coupled, 50 ohms

**Sync/Gate Bus:** 26-pin connector, clock/sync/gate/PPS input/output LVPECL bus; one gate/trigger and one sync/PPS input TTL signal

#### Field Programmable Gate Array

**Processing FPGA:** Xilinx Virtex-5 XC5VSX95T dedicated to digital downconverters and output

**Interface FPGA:** Xilinx Virtex-5 XC5VLX30T dedicated to the PCI interface

#### PCI to PCIe Interface

**PCI-X Bus:** 64-bits, 100 MHz and 64- or 32-bits at 33 or 66 MHz

**DMA:** 4 channel demand-mode and chaining controller per PCI bus

**PCIe Interface:** Gen. 2, x8 width

**PCIe Ports:** one 4X port to PCI-X bus  
one 8X port to PCIe motherboard

#### Environmental

**Operating Temp:** 0° to 50° C

**Storage Temp:** -20° to 90° C

**Relative Humidity:** 0 to 95%, non-cond.

**Size:** Half-length PCIe, 4.38 in. x 6.6 in.

### Ordering Information

Model	Description
7852	32-Channel DDC with four 200 MHz, 16-bit A/Ds - Half-length x8 PCIe

#### Options:

-731	Two-slot heat sink
------	--------------------

Contact Pentek for additional available options.

A/D Performance

Spurious-Free Dynamic Range

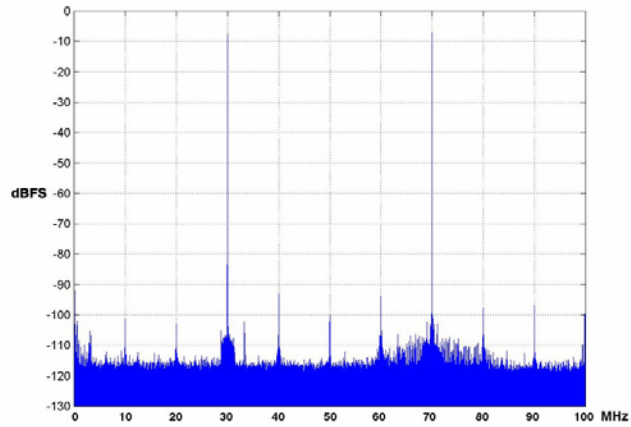

$f_{in} = 70 \text{ MHz}$ ,  $f_s = 200 \text{ MHz}$ , Internal Clock

Spurious Pickup

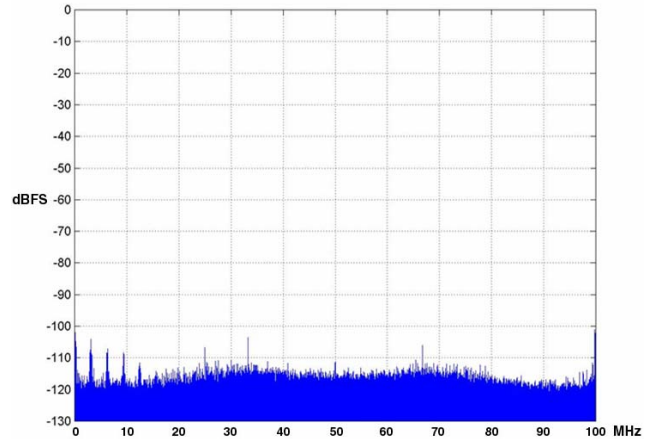

$f_s = 200 \text{ MHz}$ , Internal Clock

Input Frequency Response

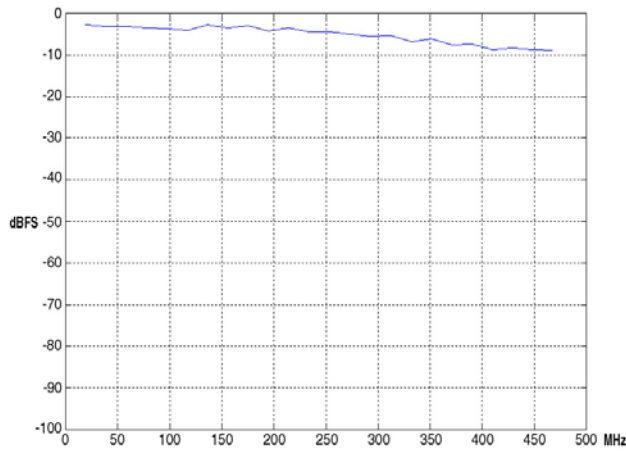

$f_s = 200 \text{ MHz}$ , Int. Clock

Two-Tone SFDR

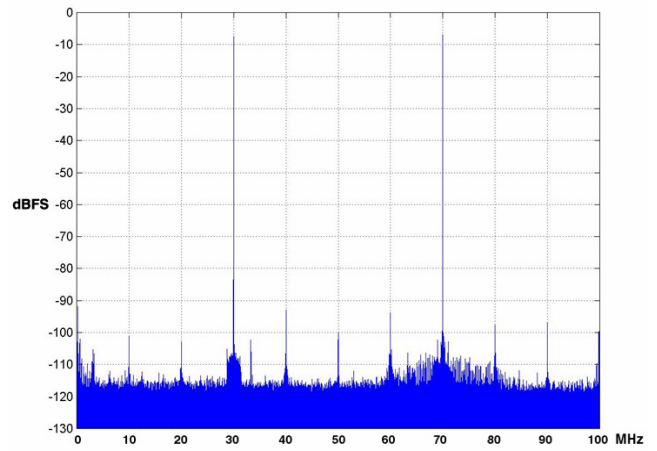

$f_{in1} = 30 \text{ MHz}$ ,  $f_{in2} = 70 \text{ MHz}$ ,  $f_s = 200 \text{ MHz}$ , Int. Clock

Adjacent Channel Crosstalk

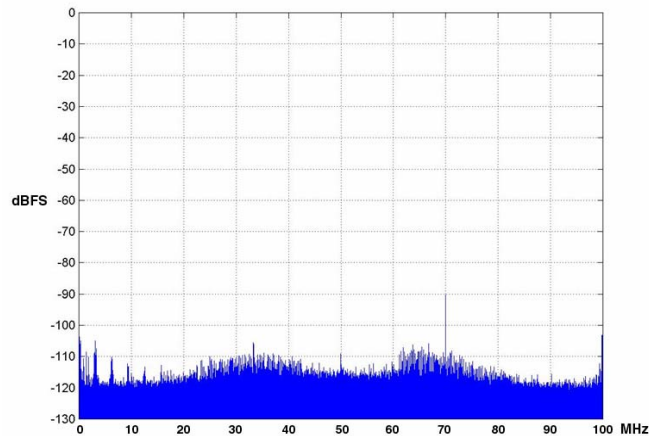

$f_{in} = 70 \text{ MHz}$ ,  $A_{in} = 0 \text{ dBFS}$ ,  $f_s = 200 \text{ MHz}$ , Int. Clock

Phase Noise at 70 MHz

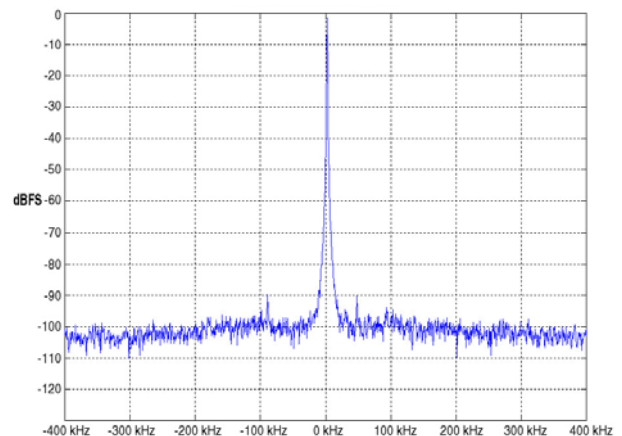

$f_s = 200 \text{ MHz}$ , Int. Clock